

LEGEND OF SYMBOLS & ABBREVIATIONS

	GAS METER		STORM DRAIN MANHOLE		ASPHALT
	WATER METER		SEWER CLEANOUT		CONCRETE
	GUY WIRE	N	NORTH		
	POWER/UTILITY POLE	S	SOUTH		
	TELEPHONE PEDESTAL	E	EAST		
	SEWER MANHOLE	W	WEST		
	WATER VALVE	(M)	AS MEASURED		
	FIRE HYDRANT	(D)	PER DEED		
	SIGNS	R/W	RIGHT-OF-WAY		
	LIGHT POLE	L.A.	LANDSCAPED AREA		
	TELEPHONE MANHOLE	CR4	CAPPED 1/2" REBAR		COMPUTED CORNER (NOT SET)
		CONC.	CONCRETE		CORRESPONDS TO DRAWING NOTE
	SS - SANITARY SEWER LINE	P.O.C.	POINT OF COMMENCEMENT		
	W - WATER LINE	P.O.B.	POINT OF BEGINNING		
	STORM SEWER PIPE	CMP	CORRUGATED METAL PIPE		
	ROADWAY CENTERLINE	RCP	REINFORCED CONCRETE PIPE		
	UTILITY EASEMENT	ESMT	EASEMENT		
	BUILDING SETBACK LINE	HDPE	HIGH DENSITY POLYETHYLENE		
	ROADWAY RIGHT-OF-WAY	SUBD	SUBDIVISION		
	OVERHEAD ELECTRIC LINES	FDC	FIRE DEPARTMENT CONNECTION		
	UNDERGROUND TELEPHONE	CPS	COTTON PICKER SPINDLE		
	UNDERGROUND GAS	PS	5/8" PIPE		
	UNDERGROUND FIBER OPTIC	R5	5/8" REBAR		
	FENCE	R4	1/2" REBAR		
	STEEL GUARD RAIL	PK	SURVEY NAIL		
	[100] - SURFACE CONTOUR LINE & ELEVATION				

CERTIFICATE OF SURVEY ACCURACY

I, ZANE ROBBINS, HEREBY CERTIFY THAT THIS PLAT CORRECTLY REPRESENTS A BOUNDARY SURVEY MADE OR VERIFIED BY ME, THAT ALL SURVEYING REQUIREMENTS OF THE STATE OF ARKANSAS AND CITY OF BRYANT SUBDIVISION RULES AND REGULATIONS HAVE BEEN COMPLIED WITH AND FILED FOR RECORD AS REQUIRED.

DATE OF EXECUTION _____
 REGISTERED PROFESSIONAL LAND SURVEYOR
 NO. 1853 ARKANSAS
 CERTIFICATE OF OWNER

WE, THE UNDERSIGNED, OWNERS OF THE REAL ESTATE SHOWN AND DESCRIBED HEREIN, DO HEREBY CERTIFY THAT WE HAVE LAID OFF, PLATTED AND SUBDIVIDED, AND DO HEREBY LAY OFF, PLAT AND SUBDIVIDE SAID REAL ESTATE IN ACCORDANCE WITH THIS PLAT.

DATE OF EXECUTION _____ SIGNED _____
 NAME _____
 ADDRESS _____

SOURCE OF TITLE: INSTRUMENT No. _____

CERTIFICATE OF ENGINEERING ACCURACY

I, PHILLIP A. LEWIS, HEREBY CERTIFY THAT THIS PLAT CORRECTLY REPRESENTS A PLAT MADE BY ME, AND THAT ENGINEERING REQUIREMENTS OF THE CITY OF BRYANT SUBDIVISION RULES AND REGULATIONS HAVE BEEN COMPLIED WITH.

SIGNED, _____
 DATE OF EXECUTION _____ REGISTERED PROFESSIONAL ENGINEER
 NO. 9540 ARKANSAS

CERTIFICATE OF FINAL PLAT APPROVAL

ALL REQUIREMENTS OF THE BRYANT SUBDIVISION RULES AND REGULATIONS RELATIVE TO THE PREPARATION AND SUBMITTAL TO A FINAL PLAT HAVE BEEN FULFILLED, APPROVAL OF THIS PLAT IS HEREBY GRANTED, SUBJECT TO FURTHER PROVISIONS OF SAID RULES AND REGULATIONS.

SIGNED, _____
 DATE OF EXECUTION _____ BRYANT PLANNING COMMISSION CHAIRMAN

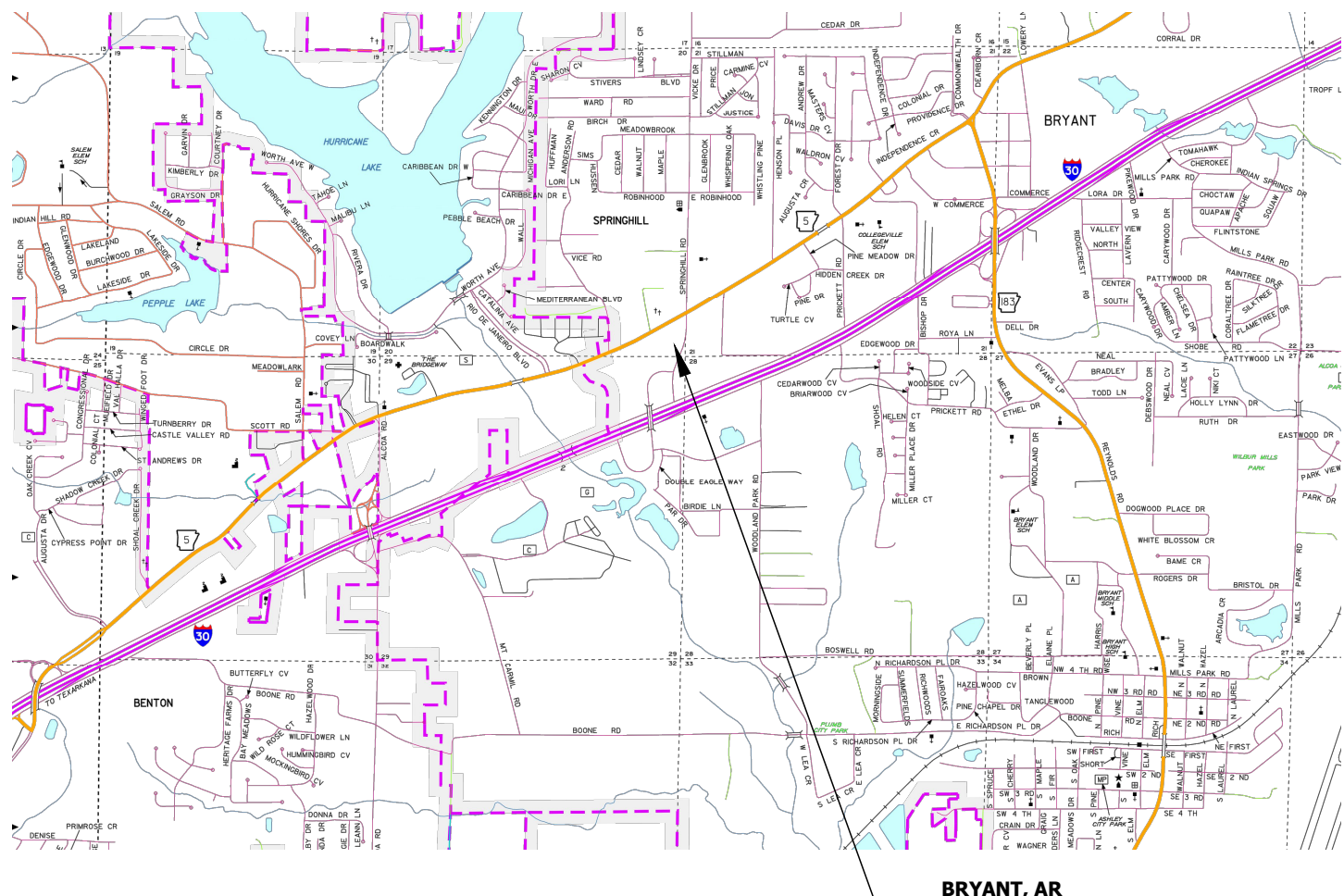

VICINITY MAP (NTS)
 BRYANT, AR
 SITE LOCATION

LAND DESCRIPTION:

A part of the Southeast Quarter of the Southeast Quarter of Section 20, Township 1 South, Range 14 West, Saline County, Arkansas, described as follows: Commencing at a #4 rebar marking the Southeast corner of Section 20, Township 1 South, Range 14 West; thence North 87 deg. 39 min. 39 sec. West (measured North 87 deg. 53 min. 51 sec. West) along the South line of said Section 20 a distance of 216.77 feet to a point on the Westerly right-of-way line of Springhill Road Crossover as established by AHTD Job #060711 said point being the point of beginning; thence continue North 87 deg. 40 min. 16 sec. West (measured North 87 deg. 53 min. 51 sec. West) along the South line of said Section 20 for 40.89 feet to a rebar with cap #568, said point also being the Southwest corner of land described in Document Number 2004-073448, records of Saline County, Arkansas; thence North 05 deg. 11 min. 29 sec. West (measured North 05 deg. 25 min. 41 sec. West) along the West line of land described in Document Number 2004-073448 for 467.18 feet; thence North 60 deg. 20 min. 26 sec. East 149.95 feet; thence South 53 deg. 05 min. 43 sec. East 53.18 feet; thence South 00 deg. 02 min. 31 sec. West 140.95 feet to a point on the Westerly right-of-way line of Springhill Road Crossover as established by AHTD Job #060711; thence along said Westerly right-of-way line of Springhill Road Crossover as established by AHTD Job #060711 the following courses: thence South 13 deg. 12 min. 03 sec. West (measured South 12 deg. 57 min. 52 sec. West) 158.40 feet; thence South 30 deg. 03 min. 32 sec. West (measured South 29 deg. 49 min. 21 sec. West) 122.38 feet; thence South 25 deg. 56 min. 09 sec. West (measured South 25 deg. 41 min. 57 sec. West) 171.72 feet to the point of beginning, containing 2.21 acres, more or less.

GENERAL NOTES

- BASIS OF BEARING FOR THIS SURVEY IS ARKANSAS STATE PLANE GRID SOUTH. DISTANCES SHOWN ARE GROUND DISTANCES.
- REFERENCES:
 - SURVEY BY GARNAT ENGINEERING FOR MERCHANTS AND FARMERS BANK DATED 8-16-22.
 - SURVEY BY RASBURY SURVEYING FOR MERCHANTS & FARMERS BANK DATED 3-9-16.

CERTIFICATION

I HEREBY CERTIFY THAT THE ABOVE PLAT REPRESENTS A SURVEY MADE BY ME OR UNDER MY SUPERVISION ON THIS DAY AND THAT ALL CORNERS ARE SET AS SHOWN. NO INDEPENDENT SEARCH FOR EASEMENTS, COVENANTS, ENCUMBRANCES, OR ANY OTHER FACTS WHICH AN ACCURATE TITLE SEARCH MAY DISCLOSE WAS PERFORMED.

ZANE ROBBINS, AR PLS #1853

UTILITY NOTES

- UTILITIES SHOWN ON THIS SURVEY ARE NOTED BY VISIBLE OBSERVATION ONLY. LOCATION OF UNDERGROUND UTILITIES SHOWN ON THIS SURVEY MUST BE CONSIDERED TO BE APPROXIMATE AS NO EXCAVATION HAS TAKEN PLACE AS OF THIS DATE TO DETERMINE THEIR EXACT LOCATION. OTHER UTILITIES, TO WHICH THE EXISTENCE AND LOCATION ARE UNKNOWN, MAY BE LOCATED ON OR NEAR THE SUBJECT PROPERTY.

FLOOD STATEMENT:
 BY GRAPHIC PLOTTING ALONE, ACCORDING TO FEMA FIRM #05125C0360E, DATED JUNE 5, 2020, THIS PROPERTY LIES IN ZONE X, AREAS OF MINIMAL FLOOD HAZARD.

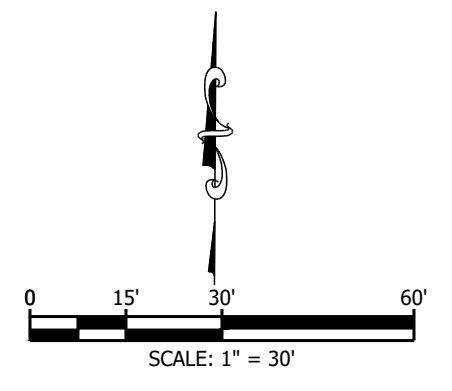
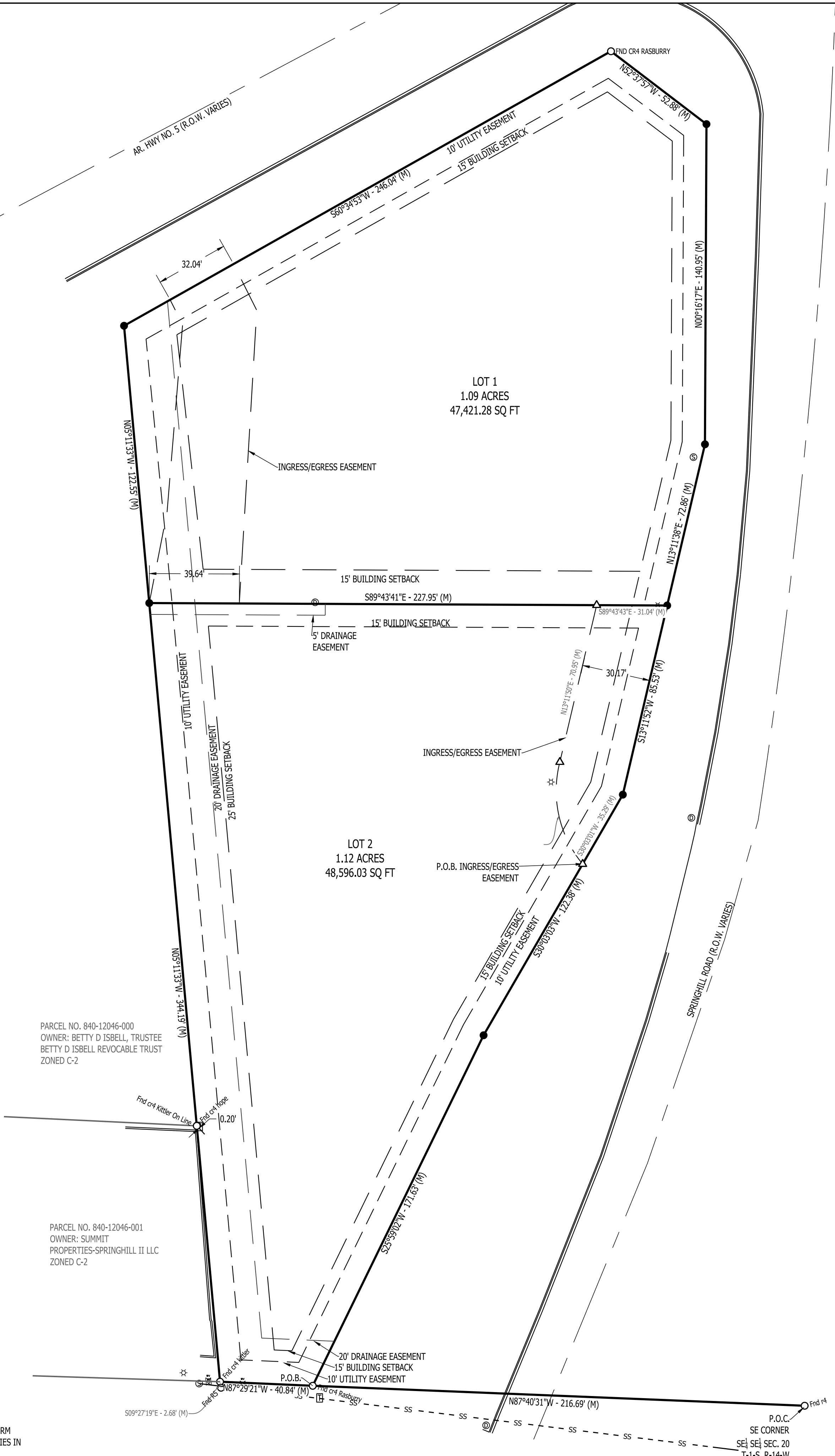

DATE	REVISIONS

PROPERTY ADDRESS
 SPRINGHILL ROAD
 BRYANT, AR.

**LOTS 1 AND 2, M & F SUBDIVISION
 BRYANT
 SALINE COUNTY, ARKANSAS**

PRELIMINARY FINAL PLAT

ROBBINS PROFESSIONAL LAND SERVICES
 INCORPORATED

SURVEYING | GIS | CONSTRUCTION STAKING

100 BOX 1991 | BRYANT, ARKANSAS 72809
 OFFICE: 501-852-0800 | 1001 THE CENTER DR BRYANT, ARKANSAS

DRAWN BY	ZR
CHECKED BY	ZR
DATE	5-3-24
SCALE	1"=30'
PROJECT No.	2024125
SHEET	--
PAGE	1 of 1

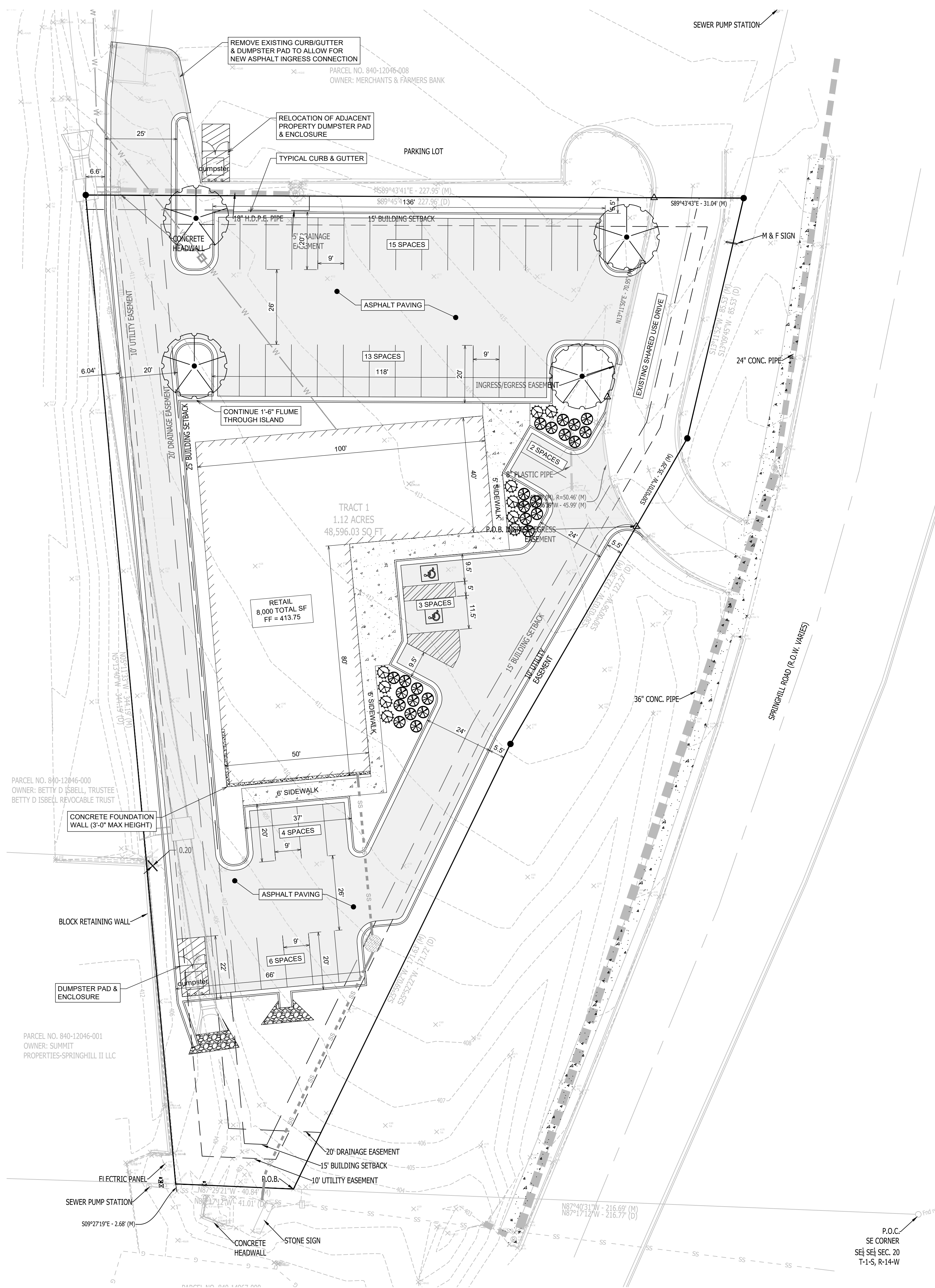

SITE PLAN

SCALE 1" = 20'

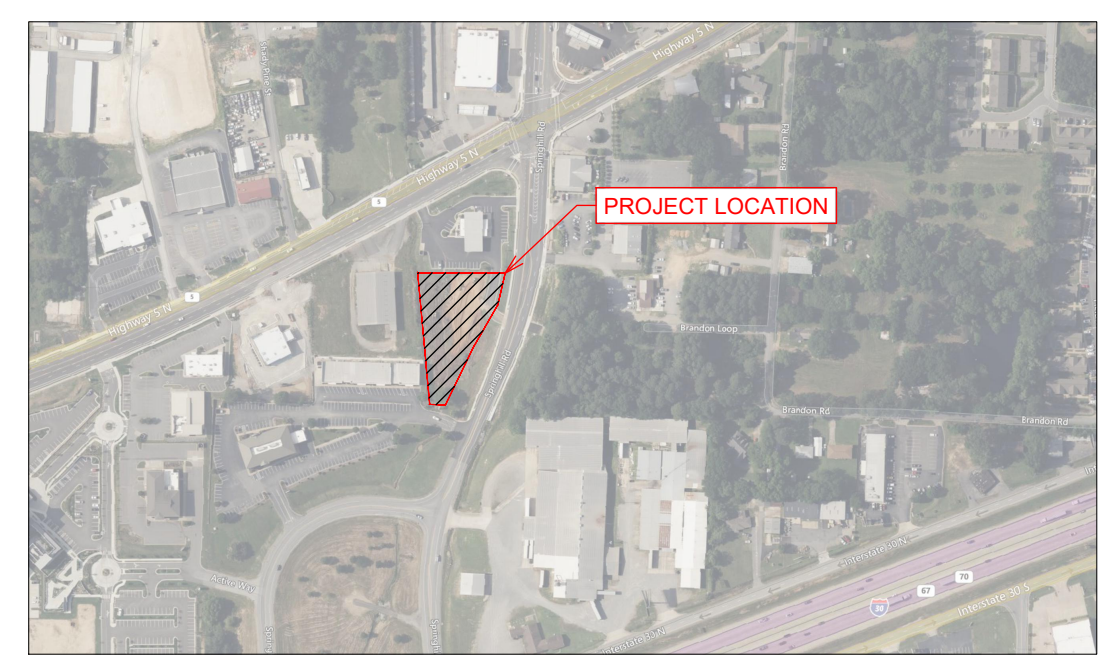

Vicinity Map

SCALE 1" = 500'

GENERAL SITE NOTES

- TOTAL NEW DEVELOPMENT AREA = (+/-) 1.12 ACRES
- PROPERTY IS ZONED C-2
- 43 PARKING SPACES PROVIDED INCLUDING 2 ADA ACCESSIBLE PARKING SPACES
- ALL DIMENSIONS ARE TO THE BACK OF CURB AND/OR EDGE OF PAVEMENT
- DAMAGE TO PUBLIC AND PRIVATE PROPERTY DUE TO HAULING OPERATIONS OR OPERATIONS OF CONSTRUCTION RELATED EQUIPMENT FROM A CONSTRUCTION SITE SHALL BE REPAIRED BY THE THE RESPONSIBLE PARTY PRIOR TO THE ISSUANCE OF A CERTIFICATE OF OCCUPANCY.
- REPAIR, REPLACE, OR EXTEND EXISTING DAMAGED OR MISSING CURB AND GUTTER, SIDEWALK OR RAMPS WITHIN THE PUBLIC RIGHT OF WAY.
- ALL SIGNAGE, PAVEMENT MARKING AND PARKING LOT STRIPING SHALL CONFORM TO REQUIREMENTS GIVEN IN MANUAL OF UNIFORM TRAFFIC CONTROL DEVICES (MUTCD). MUTCD REQUIRES THAT PARKING SPACES BE MARKED IN WHITE.

PARKING CALCULATIONS

ZONING = C-2
 REQUIREMENT = 1 SPACE PER 200 SQ. FT.
 BUILDING AREA = 8,000 SQ. FT.
 TOTAL REQUIRED SPACES = 40
 TOTAL PROVIDED SPACES = 43

GENERAL CONSTRUCTION NOTES

- THE CONTRACTOR WILL BE HELD SOLELY RESPONSIBLE FOR DAMAGES OCCURRING TO ANY PROPERTY DURING THE CONSTRUCTION OF THIS PROJECT. SAID CONTRACTOR SHALL TAKE ALL NECESSARY PRECAUTIONS TO PREVENT PROPERTY DAMAGE.
- IN ACCORDANCE WITH GENERALLY ACCEPTED CONSTRUCTION PRACTICES, THE CONTRACTOR WILL SOLELY AND COMPLETELY BE RESPONSIBLE FOR CONDITIONS OF THE JOB SITE, INCLUDING SAFETY WORK. THIS REQUIREMENT WILL APPLY CONTINUOUSLY AND WILL NOT BE LIMITED TO NORMAL WORKING HOURS.
- THE DUTY OF BRYANT UTILITIES TO CONDUCT CONSTRUCTION INSPECTION REVIEWS OF THE CONTRACTOR'S PERFORMANCE IS NOT AN INSPECTION OR REVIEW OF THE ADEQUACY OF THE CONTRACTOR'S SAFETY MEASURES IN, ON, OR NEAR THE CONSTRUCTION SITE.
- ALL WATER AND SEWER IMPROVEMENTS SHALL BE CONSTRUCTED IN ACCORDANCE WITH THE LATEST REVISION TO THE CITY OF BRYANT'S WATER AND WASTEWATER (SANITARY SEWER) STANDARD SPECIFICATIONS.
- THE CONTRACTOR IS SPECIFICALLY CAUTIONED THAT THE LOCATION AND/OR ELEVATION OF EXISTING UTILITIES AS SHOWN ON THESE PLANS IS BASED ON RECORDS OF THE VARIOUS UTILITY COMPANIES AND, WHERE POSSIBLE, MEASUREMENTS TAKEN IN THE FIELD. THE INFORMATION IS NOT TO BE RELIED ON AS BEING EXACT OR COMPLETE. THE CONTRACTOR MUST CALL THE APPROPRIATE UTILITY COMPANY AT LEAST 48 HOURS BEFORE ANY EXCAVATION TO REQUEST EXACT FIELD LOCATION OF ALL UTILITIES. IT SHALL BE THE RESPONSIBILITY OF THE CONTRACTOR TO LOCATE ALL EXISTING UTILITIES WHICH CONFLICT WITH PROPOSED IMPROVEMENTS SHOWN ON THE PLAN.
- CONTRACTOR IS TO REMOVE AND DISPOSE OF ALL DEBRIS, RUBBISH, AND OTHER MATERIALS RESULTING FROM PREVIOUS AND CURRENT DEMOLITION OPERATIONS. DISPOSAL WILL BE IN ACCORDANCE WITH ALL LOCAL, STATE AND/OR FEDERAL REGULATIONS GOVERNING SUCH OPERATIONS.
- PRIOR TO INSTALLATION OF ANY UTILITIES, THE CONTRACTOR IS TO EXCAVATE, VERIFY AND CALCULATE ALL CROSSINGS AND INFORM ANY AND ALL UTILITIES OF ANY CONFLICTS PRIOR TO CONSTRUCTION.
- CONSTRUCTION SHALL NOT START ON ANY WATER UTILITY TIE-INS UNTIL APPROVAL IS GIVEN BY BRYANT UTILITIES. SAID CONTRACTOR SHALL NOT OPERATE ANY VALVE, HYDRANT, OR WATER UTILITY APPURTENANCE NOR SHALL HE ATTACH TO OR TAP ANY WATER UTILITY MAIN WITHOUT APPROVAL. THE CONTRACTOR SHALL BEAR THE COST AND CONSEQUENCE OF ANY DISRUPTION OF UTILITY OPERATION CAUSED BY CONSTRUCTION.
- FIBER OPTIC CABLE ON AND/OR ADJACENT TO THIS SITE WERE NOT LOCATED BY THE SURVEY AND ARE NOT SHOWN. IT IS THE RESPONSIBILITY OF THE CONTRACTOR TO LOCATE ANY FIBER OPTIC CABLES ASSOCIATED WITH THIS SITE AND TAKE ALL NECESSARY AND REQUIRED PRECAUTIONS TO PROTECT ANY EXISTING FIBER OPTIC CABLES. CONTRACTORS SHALL COORDINATE ALL EFFORTS WITH OWNER OF FIBER OPTIC CABLES OR THEIR DESIGNATED REPRESENTATIVE.
- THE CONTRACTOR IS RESPONSIBLE FOR CONTACTING "ONECALL" SERVICE TO MARK ALL UTILITIES PRIOR TO ANY DEMOLITION, EARTHWORK, OR UTILITY WORK ON THIS SITE.

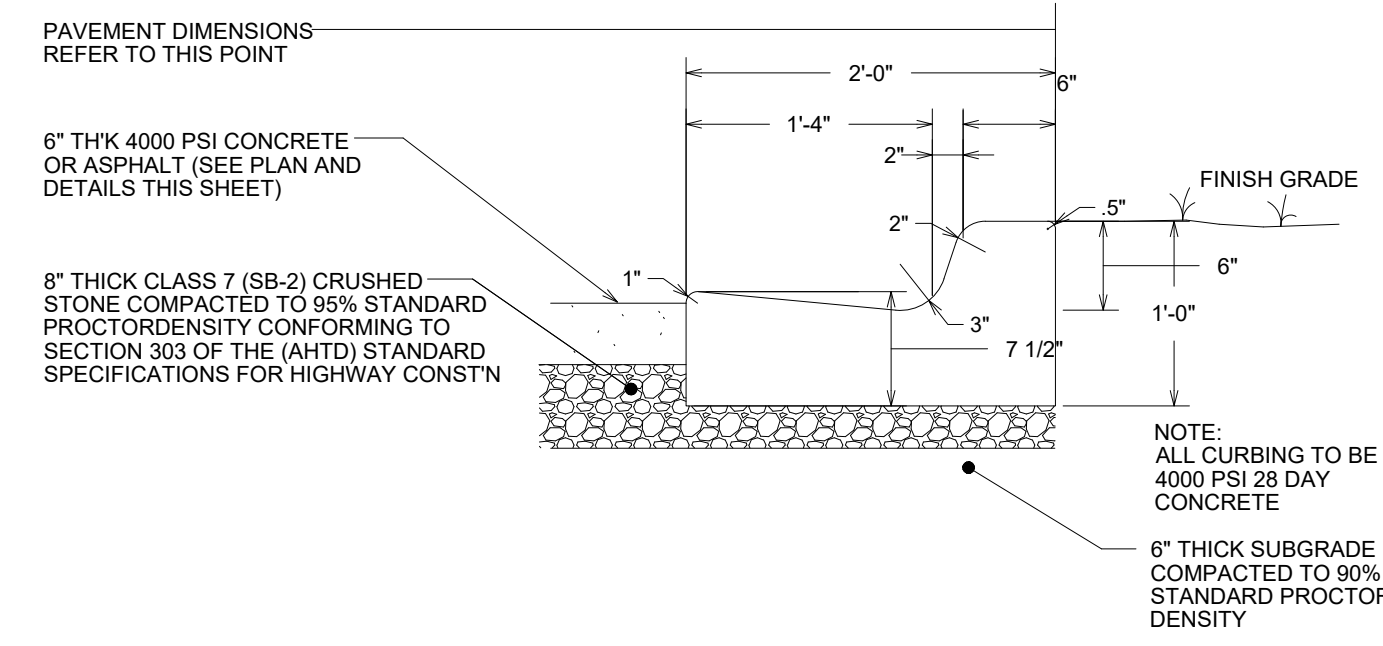

2'-0" CONCRETE CURB & GUTTER

NOT TO SCALE

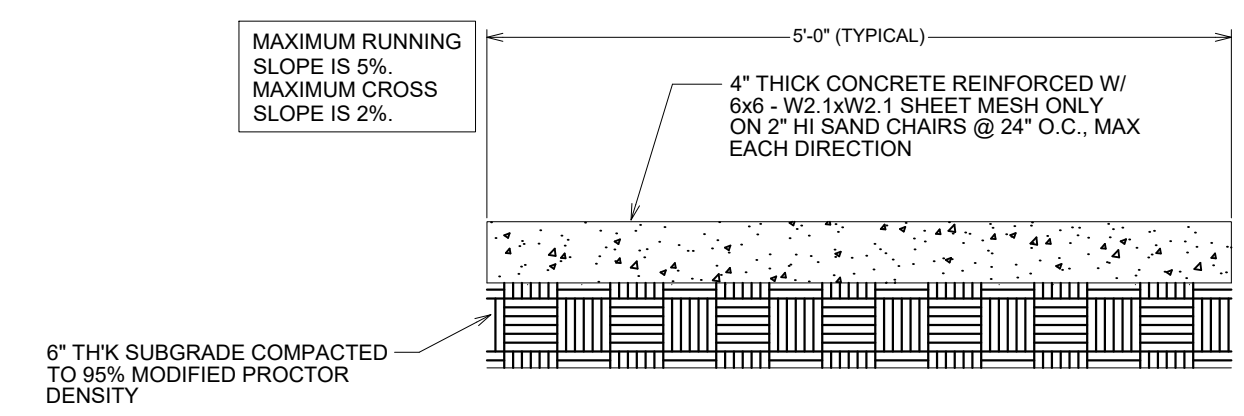

CONCRETE WALK SECTION

NOT TO SCALE

NOTE:
 1. ALL SIDEWALK JOINTS TO BE STEEL TROWELED. ALL JOINT EDGES AND SHALL BE SPACED AT 4 FEET ON CENTER (MAXIMUM IN ALL DIRECTIONS) AND SHALL BE STEEL TROWELED ON A RADIUS NOT TO EXCEED ONE-HALF INCH.
 2. CONTRACTOR TO BE RESPONSIBLE FOR ENSURING ADA COMPLIANT RUNNING & CROSS SLOPES. SPOT GRADES SHOWN ON ENGINEERING PLANS SHOW BEST INTENT WITH AVAILABLE INFORMATION.

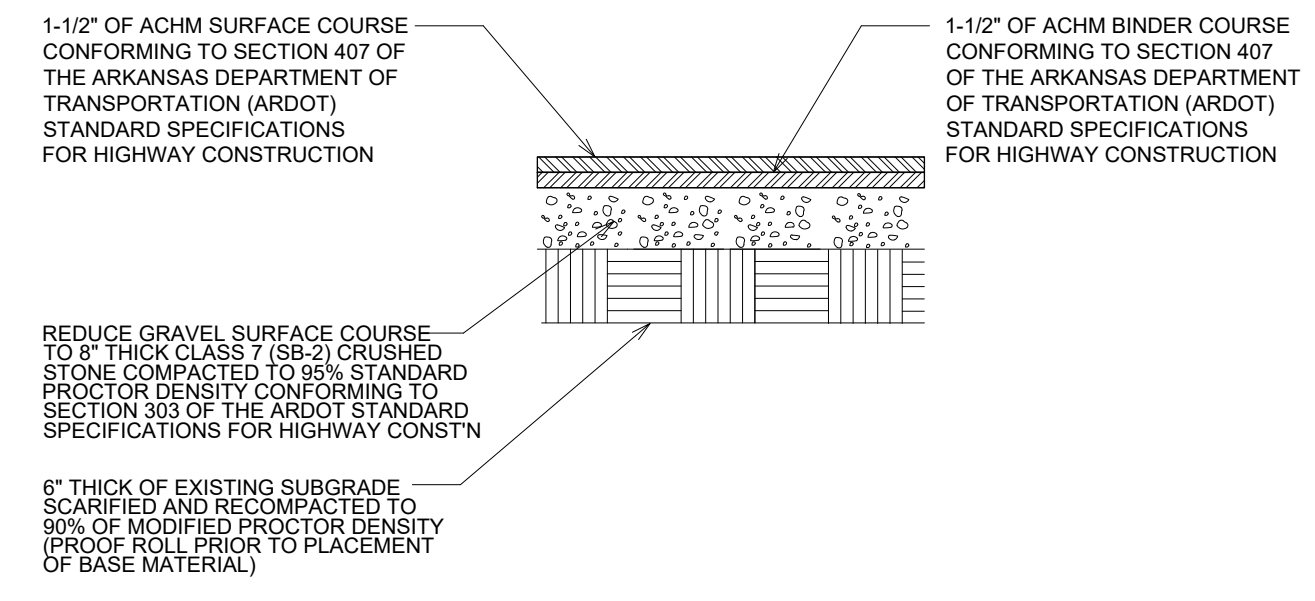

HMC ASPHALT SURFACE COURSE MEDIUM DUTY

NOT TO SCALE

PHILLIP LEWIS ENGINEERING, INC.
 Structural + Civil Consultants
 23620 Interstate 30 | Bryant, Arkansas
 PH: 501-350-9840

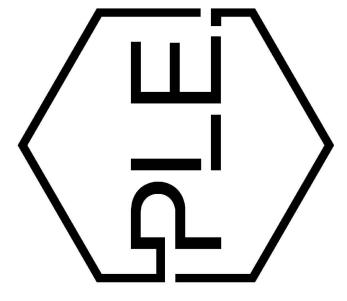

REVISION:

SPRINGHILL RETAIL

BRYANT, ARKANSAS

PROJECT NUMBER:

SHEET ISSUE DATE: 05-22-2024

PAGE TITLE: SITE PLAN

SHEET NUMBER: C1.1

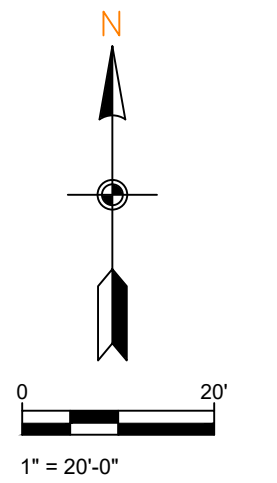

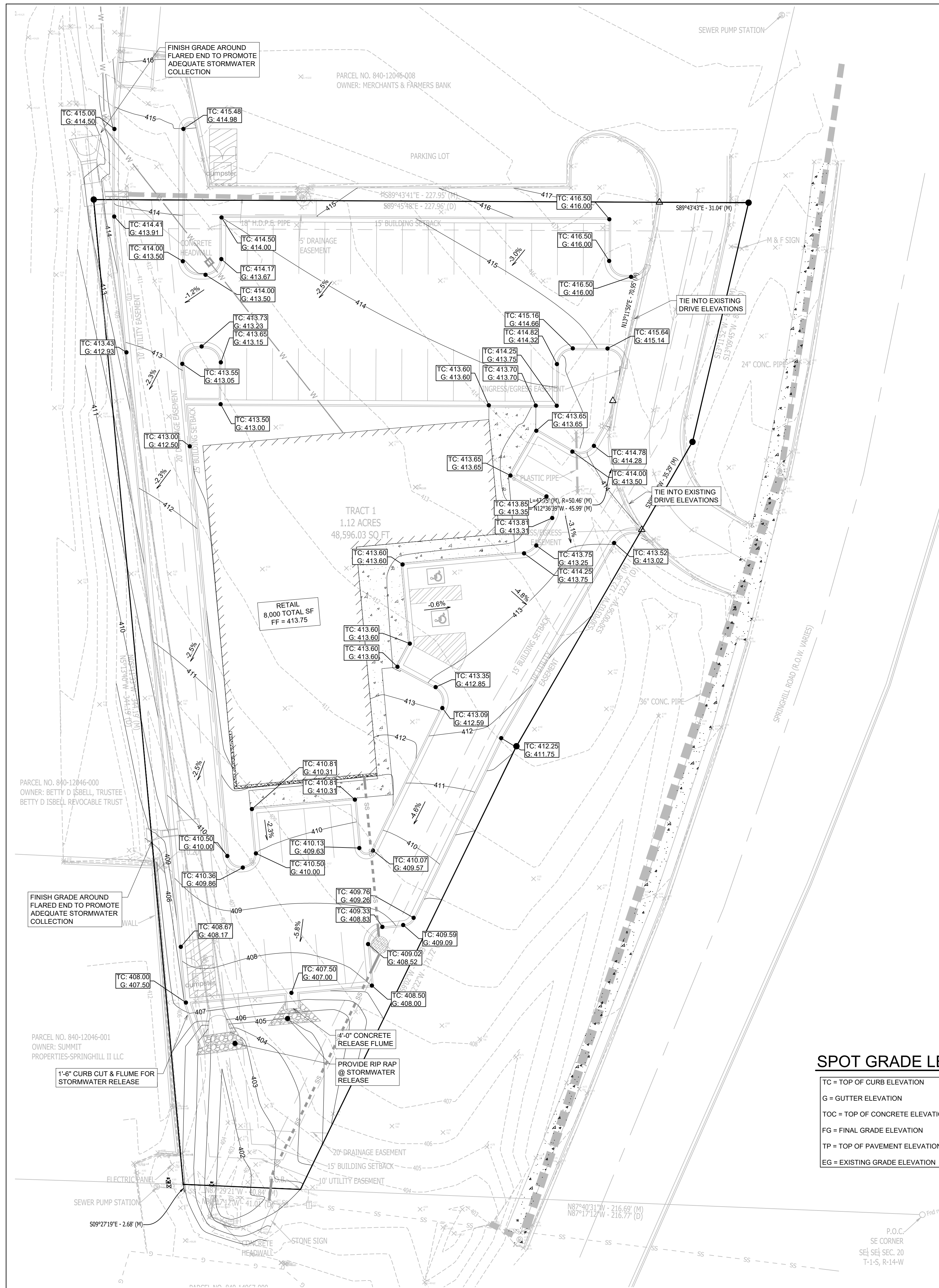

SPOT GRADE LEGEND

- TC = TOP OF CURB ELEVATION
- G = GUTTER ELEVATION
- TOC = TOP OF CONCRETE ELEVATION
- FG = FINAL GRADE ELEVATION
- TP = TOP OF PAVEMENT ELEVATION
- EG = EXISTING GRADE ELEVATION

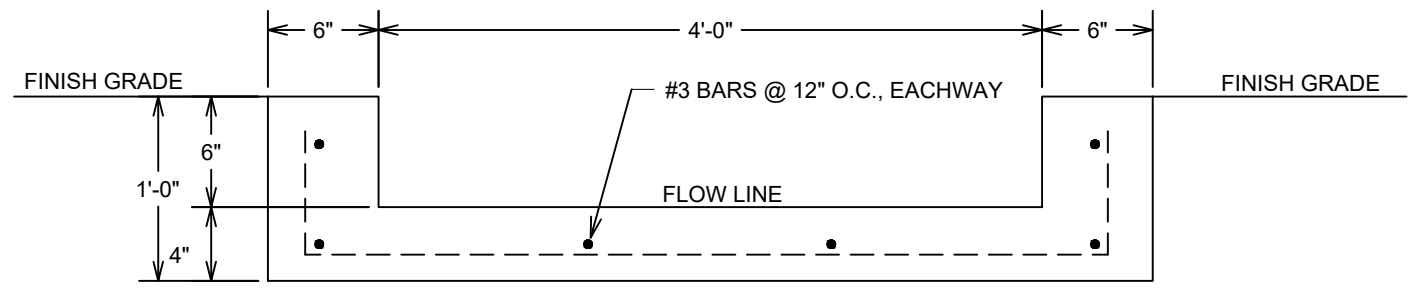

CONCRETE FLUME DETAIL NOT TO SCALE

GENERAL CONSTRUCTION NOTES

- A. THE CONTRACTOR WILL BE HELD SOLELY RESPONSIBLE FOR DAMAGES OCCURRING TO ANY PROPERTY DURING THE CONSTRUCTION OF THIS PROJECT. SAID CONTRACTOR SHALL TAKE ALL NECESSARY PRECAUTIONS TO PREVENT PROPERTY DAMAGE.
- B. IN ACCORDANCE WITH GENERALLY ACCEPTED CONSTRUCTION PRACTICES, THE CONTRACTOR WILL SOLELY AND COMPLETELY BE RESPONSIBLE FOR CONDITIONS OF THE JOB SITE, INCLUDING SAFETY WORK. THIS REQUIREMENT WILL APPLY CONTINUOUSLY AND WILL NOT BE LIMITED TO NORMAL WORKING HOURS.
- C. THE DUTY OF BRYANT UTILITIES TO CONDUCT CONSTRUCTION INSPECTION REVIEWS OF THE CONTRACTOR'S PERFORMANCE IS NOT AN INSPECTION OR REVIEW OF THE ADEQUACY OF THE CONTRACTOR'S SAFETY MEASURES IN, ON, OR NEAR THE CONSTRUCTION SITE.
- D. ALL WATER AND SEWER IMPROVEMENTS SHALL BE CONSTRUCTED IN ACCORDANCE WITH THE LATEST REVISION TO THE CITY OF BRYANT'S WATER AND WASTEWATER (SANITARY SEWER) STANDARD SPECIFICATIONS.
- E. THE CONTRACTOR IS SPECIFICALLY CAUTIONED THAT THE LOCATION AND/OR ELEVATION OF EXISTING UTILITIES AS SHOWN ON THESE PLANS IS BASED ON RECORDS OF THE VARIOUS UTILITY COMPANIES AND, WHERE POSSIBLE, MEASUREMENTS TAKEN IN THE FIELD. THE INFORMATION IS NOT TO BE RELIED ON AS BEING EXACT OR COMPLETE. THE CONTRACTOR MUST CALL THE APPROPRIATE UTILITY COMPANY AT LEAST 48 HOURS BEFORE ANY EXCAVATION TO REQUEST EXACT FIELD LOCATION OF ALL UTILITIES. IT SHALL BE THE RESPONSIBILITY OF THE CONTRACTOR TO LOCATE ALL EXISTING UTILITIES WHICH CONFLICT WITH PROPOSED IMPROVEMENTS SHOWN ON THE PLAN.
- F. CONTRACTOR IS TO REMOVE AND DISPOSE OF ALL DEBRIS, RUBBISH, AND OTHER MATERIALS RESULTING FROM PREVIOUS AND CURRENT DEMOLITION OPERATIONS. DISPOSAL WILL BE IN ACCORDANCE WITH ALL LOCAL, STATE AND/OR FEDERAL REGULATIONS GOVERNING SUCH OPERATIONS.
- G. PRIOR TO INSTALLATION OF ANY UTILITIES, THE CONTRACTOR IS TO EXCAVATE, VERIFY AND CALCULATE ALL CROSSINGS AND INFORM ANY AND ALL UTILITIES OF ANY CONFLICTS PRIOR TO CONSTRUCTION.
- H. CONSTRUCTION SHALL NOT START ON ANY WATER UTILITY TIE-INS UNTIL APPROVAL IS GIVEN BY BRYANT UTILITIES. SAID CONTRACTOR SHALL NOT OPERATE ANY VALVE, HYDRANT, OR WATER UTILITY APPURTENANCE NOR SHALL HE ATTACH TO OR TAP ANY WATER UTILITY MAIN WITHOUT APPROVAL. THE CONTRACTOR SHALL BEAR THE COST AND CONSEQUENCE OF ANY DISRUPTION OF UTILITY OPERATION CAUSED BY CONSTRUCTION.
- I. FIBER OPTIC CABLE ON AND/OR ADJACENT TO THIS SITE WERE NOT LOCATED BY THE SURVEY AND ARE NOT SHOWN. IT IS THE RESPONSIBILITY OF THE CONTRACTOR TO LOCATE ANY FIBER OPTIC CABLES ASSOCIATED WITH THIS SITE AND TAKE ALL NECESSARY AND REQUIRED PRECAUTIONS TO PROTECT ANY EXISTING FIBER OPTIC CABLES. CONTRACTORS SHALL COORDINATE ALL EFFORTS WITH OWNER OF FIBER OPTIC CABLES OR THEIR DESIGNATED REPRESENTATIVE.
- J. THE CONTRACTOR IS RESPONSIBLE FOR CONTACTING "ONECALL" SERVICE TO MARK ALL UTILITIES PRIOR TO ANY DEMOLITION, EARTHWORK, OR UTILITY WORK ON THIS SITE.

PHILLIP LEWIS ENGINEERING, INC.
Structural + Civil Consultants
23620 Interstate 30 | Bryant, Arkansas
PH: 501-350-9840

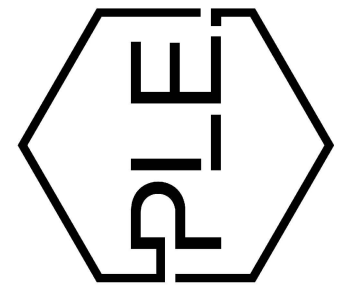

REVISION:

SPRINGHILL RETAIL
BRYANT, ARKANSAS

PROJECT NUMBER:
SHEET ISSUE DATE: 05-22-2024
PAGE TITLE: **GRADING PLAN**
SHEET NUMBER: **C1.2**

GRADING PLAN

SCALE 1" = 20'

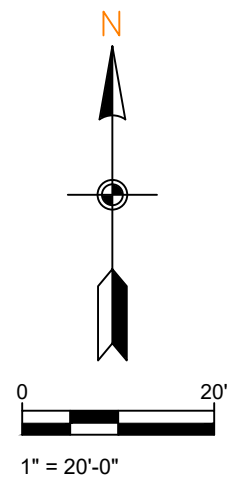

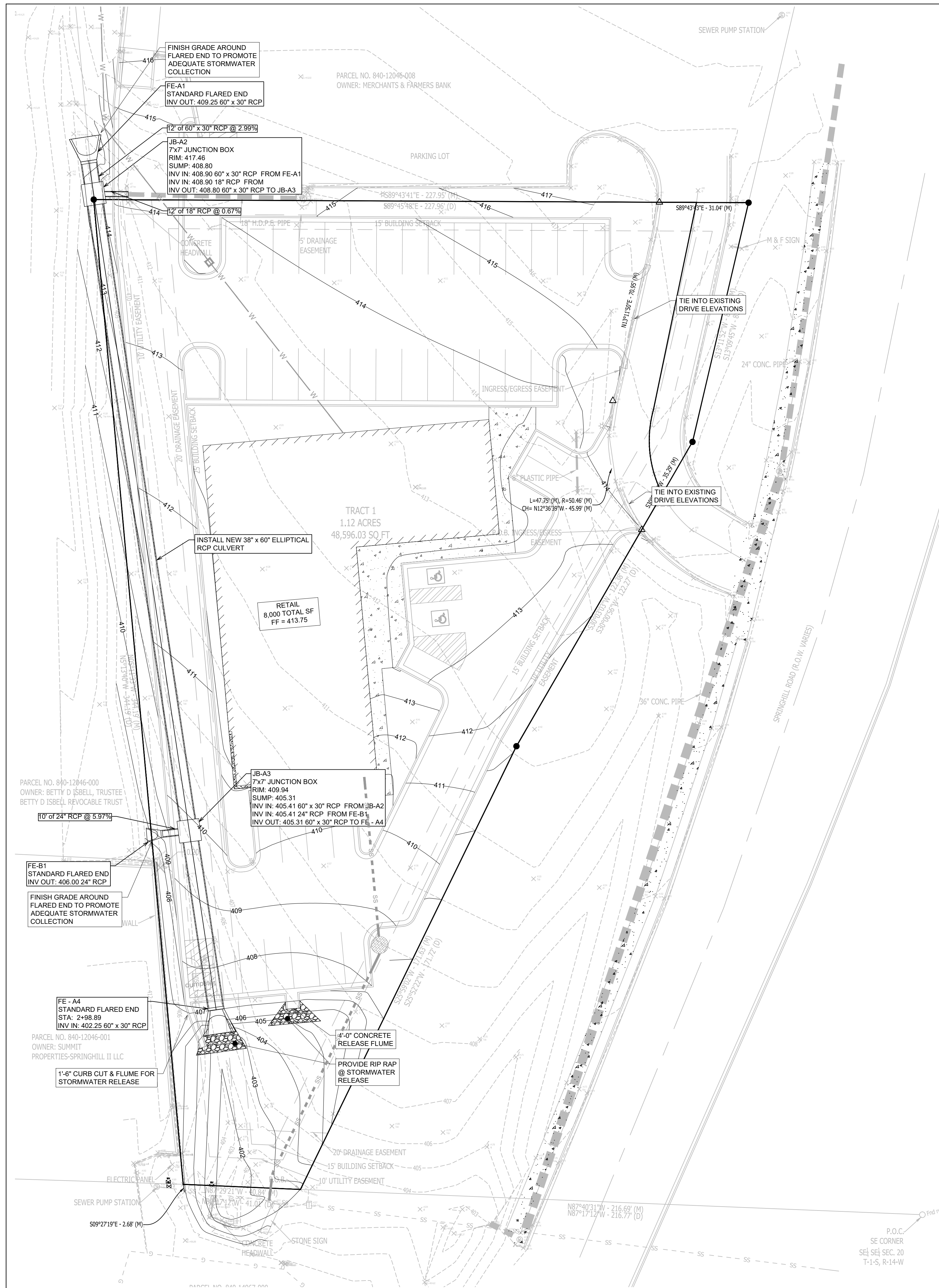

STORM DRAINAGE PLAN

SCALE 1" = 20'

GENERAL CONSTRUCTION NOTES

- A. THE CONTRACTOR WILL BE HELD SOLELY RESPONSIBLE FOR DAMAGES OCCURRING TO ANY PROPERTY DURING THE CONSTRUCTION OF THIS PROJECT. SAID CONTRACTOR SHALL TAKE ALL NECESSARY PRECAUTIONS TO PREVENT PROPERTY DAMAGE.
- B. IN ACCORDANCE WITH GENERALLY ACCEPTED CONSTRUCTION PRACTICES, THE CONTRACTOR WILL SOLELY AND COMPLETELY BE RESPONSIBLE FOR CONDITIONS OF THE JOB SITE, INCLUDING SAFETY WORK. THIS REQUIREMENT WILL APPLY CONTINUOUSLY AND WILL NOT BE LIMITED TO NORMAL WORKING HOURS.
- C. THE DUTY OF BRYANT UTILITIES TO CONDUCT CONSTRUCTION INSPECTION REVIEWS OF THE CONTRACTOR'S PERFORMANCE IS NOT AN INSPECTION OR REVIEW OF THE ADEQUACY OF THE CONTRACTOR'S SAFETY MEASURES IN, ON, OR NEAR THE CONSTRUCTION SITE.
- D. ALL WATER AND SEWER IMPROVEMENTS SHALL BE CONSTRUCTED IN ACCORDANCE WITH THE LATEST REVISION TO THE CITY OF BRYANT'S WATER AND WASTEWATER (SANITARY SEWER) STANDARD SPECIFICATIONS.
- E. THE CONTRACTOR IS SPECIFICALLY CAUTIONED THAT THE LOCATION AND/OR ELEVATION OF EXISTING UTILITIES AS SHOWN ON THESE PLANS IS BASED ON RECORDS OF THE VARIOUS UTILITY COMPANIES AND, WHERE POSSIBLE, MEASUREMENTS TAKEN IN THE FIELD. THE INFORMATION IS NOT TO BE RELIED ON AS BEING EXACT OR COMPLETE. THE CONTRACTOR MUST CALL THE APPROPRIATE UTILITY COMPANY AT LEAST 48 HOURS BEFORE ANY EXCAVATION TO REQUEST EXACT FIELD LOCATION OF ALL UTILITIES. IT SHALL BE THE RESPONSIBILITY OF THE CONTRACTOR TO LOCATE ALL EXISTING UTILITIES WHICH CONFLICT WITH PROPOSED IMPROVEMENTS SHOWN ON THE PLAN.
- F. CONTRACTOR IS TO REMOVE AND DISPOSE OF ALL DEBRIS, RUBBISH, AND OTHER MATERIALS RESULTING FROM PREVIOUS AND CURRENT DEMOLITION OPERATIONS. DISPOSAL WILL BE IN ACCORDANCE WITH ALL LOCAL, STATE AND/OR FEDERAL REGULATIONS GOVERNING SUCH OPERATIONS.
- G. PRIOR TO INSTALLATION OF ANY UTILITIES, THE CONTRACTOR IS TO EXCAVATE, VERIFY AND CALCULATE ALL CROSSINGS AND INFORM ANY AND ALL UTILITIES OF ANY CONFLICTS PRIOR TO CONSTRUCTION.
- H. CONSTRUCTION SHALL NOT START ON ANY WATER UTILITY TIE-INS UNTIL APPROVAL IS GIVEN BY BRYANT UTILITIES. SAID CONTRACTOR SHALL NOT OPERATE ANY VALVE, HYDRANT, OR WATER UTILITY APPURTENANCE NOR SHALL HE ATTACH TO OR TAP ANY WATER UTILITY MAIN WITHOUT APPROVAL. THE CONTRACTOR SHALL BEAR THE COST AND CONSEQUENCE OF ANY DISRUPTION OF UTILITY OPERATION CAUSED BY CONSTRUCTION.
- I. FIBER OPTIC CABLE ON AND/OR ADJACENT TO THIS SITE WERE NOT LOCATED BY THE SURVEY AND ARE NOT SHOWN. IT IS THE RESPONSIBILITY OF THE CONTRACTOR TO LOCATE ANY FIBER OPTIC CABLES ASSOCIATED WITH THIS SITE AND TAKE ALL NECESSARY AND REQUIRED PRECAUTIONS TO PROTECT ANY EXISTING FIBER OPTIC CABLES. CONTRACTORS SHALL COORDINATE ALL EFFORTS WITH OWNER OF FIBER OPTIC CABLES OR THEIR DESIGNATED REPRESENTATIVE.
- J. THE CONTRACTOR IS RESPONSIBLE FOR CONTACTING "ONECALL" SERVICE TO MARK ALL UTILITIES PRIOR TO ANY DEMOLITION, EARTHWORK, OR UTILITY WORK ON THIS SITE.

PHILLIP LEWIS ENGINEERING, INC.
Structural + Civil Consultants
23620 Interstate 30 | Bryant, Arkansas
PH: 501-350-9840

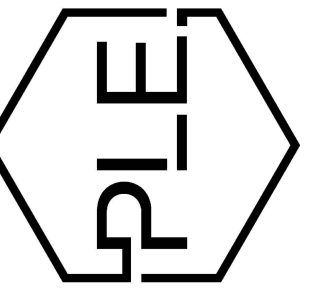

REVISION:

SPRINGHILL RETAIL
BRYANT, ARKANSAS

PROJECT NUMBER:
SHEET ISSUE DATE: 05-22-2024
PAGE TITLE: **STORM DRAINAGE PLAN**
SHEET NUMBER: **C1.3**

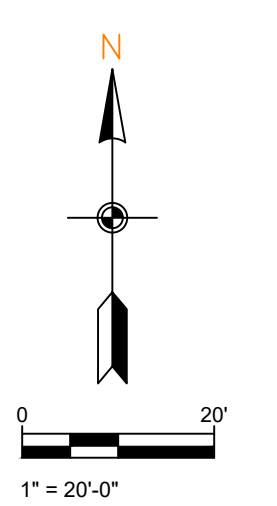

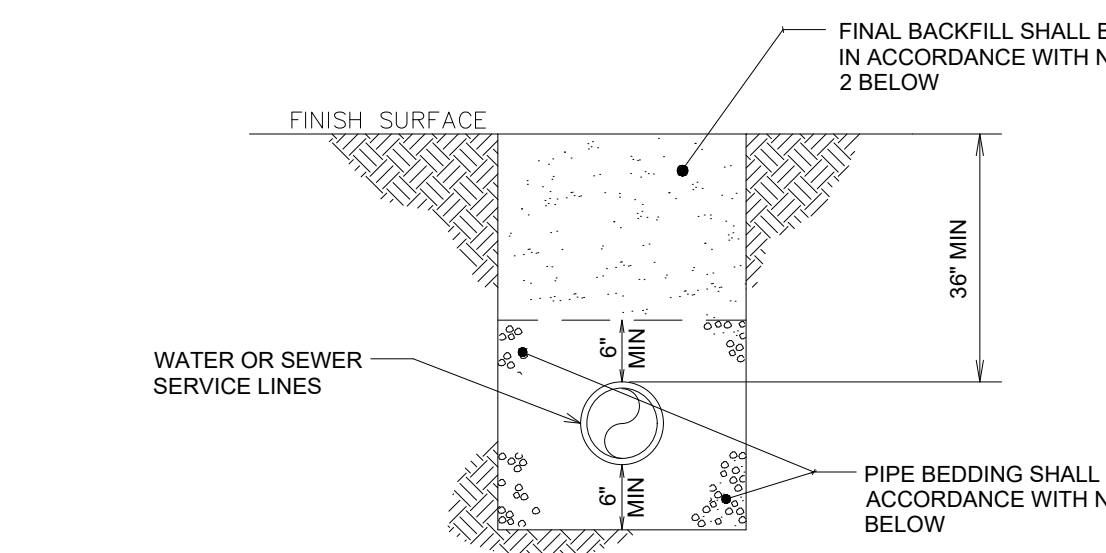
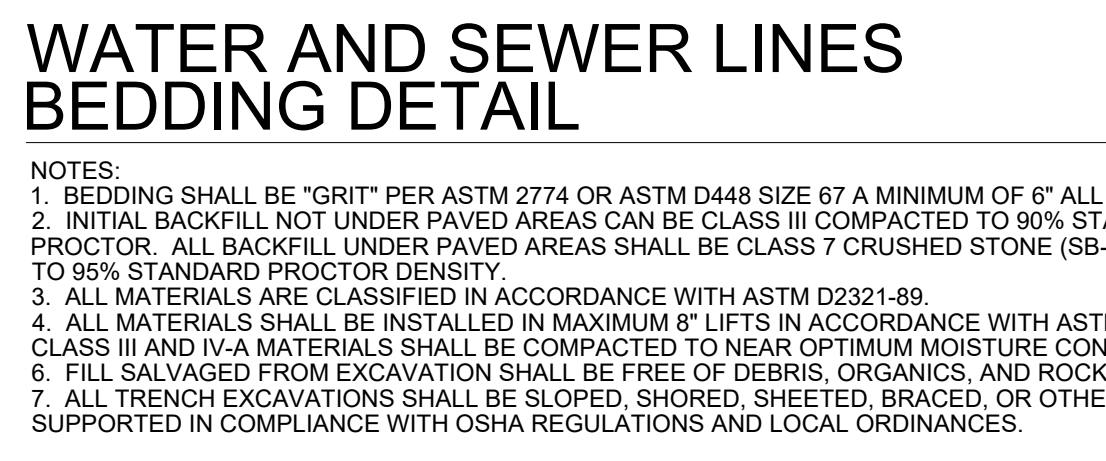
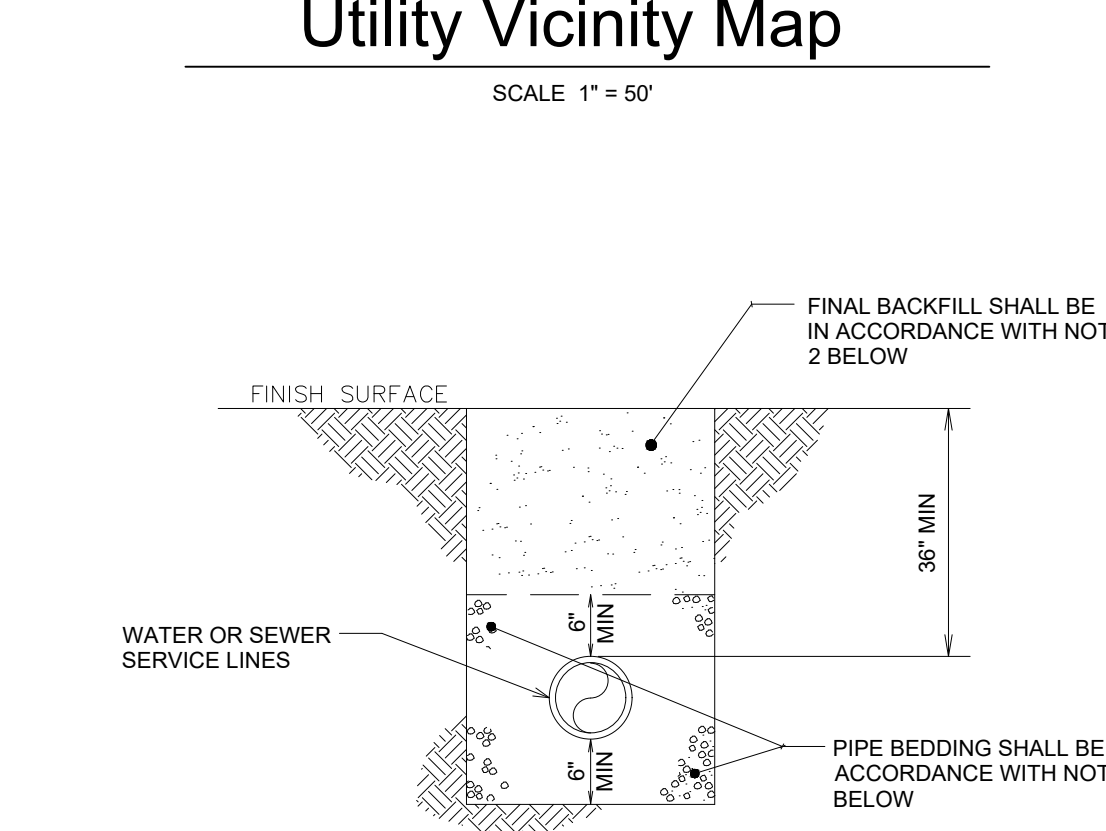
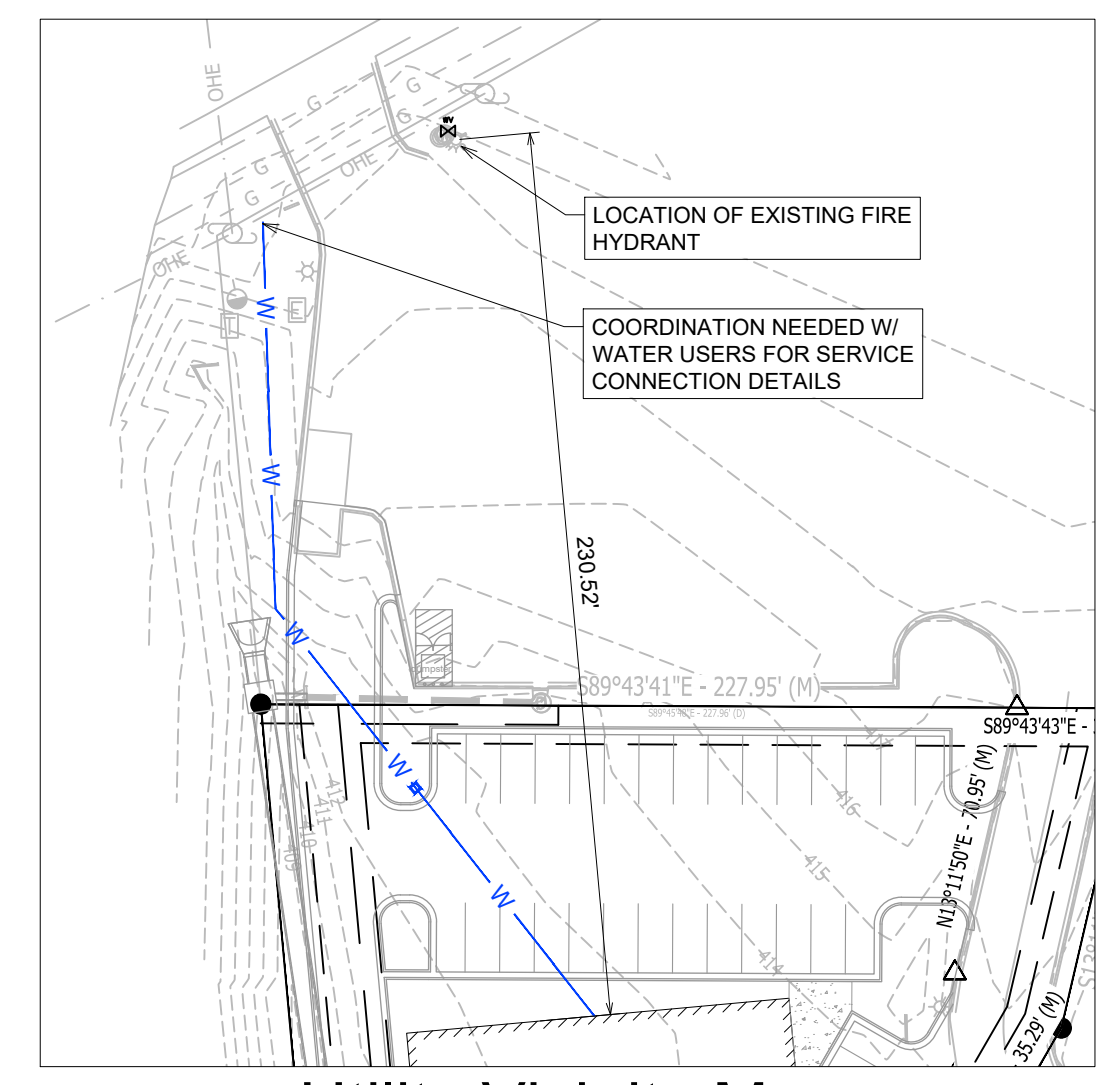
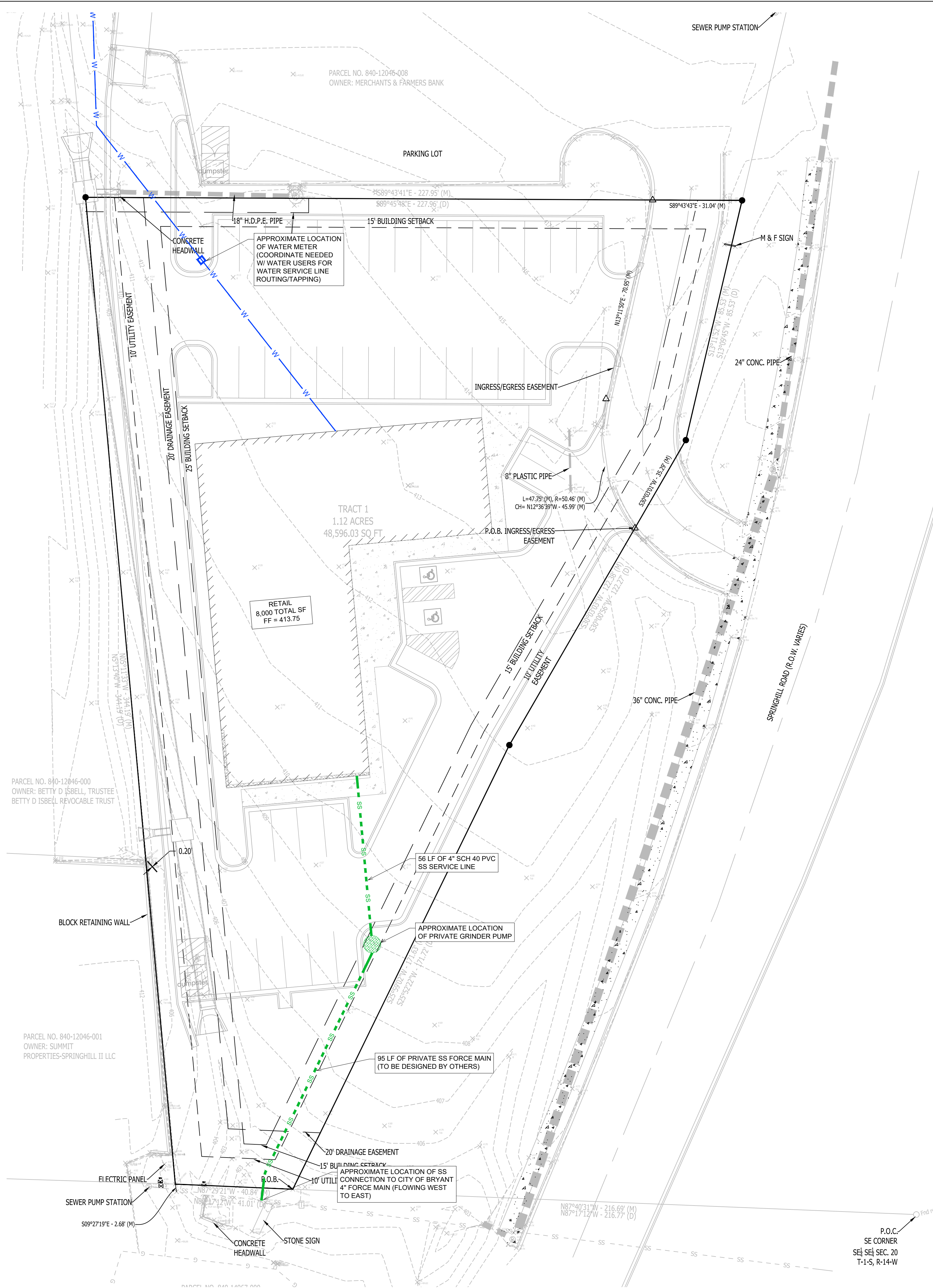

GENERAL CONSTRUCTION NOTES

- A. THE CONTRACTOR WILL BE HELD SOLELY RESPONSIBLE FOR DAMAGES OCCURRING TO ANY PROPERTY DURING THE CONSTRUCTION OF THIS PROJECT. SAID CONTRACTOR SHALL TAKE ALL NECESSARY PRECAUTIONS TO PREVENT PROPERTY DAMAGE.
- B. IN ACCORDANCE WITH GENERALLY ACCEPTED CONSTRUCTION PRACTICES, THE CONTRACTOR WILL SOLELY AND COMPLETELY BE RESPONSIBLE FOR CONDITIONS OF THE JOB SITE, INCLUDING SAFETY WORK. THIS REQUIREMENT WILL APPLY CONTINUOUSLY AND WILL NOT BE LIMITED TO NORMAL WORKING HOURS.
- C. THE DUTY OF BRYANT UTILITIES TO CONDUCT CONSTRUCTION INSPECTION REVIEWS OF THE CONTRACTOR'S PERFORMANCE IS NOT AN INSPECTION OR REVIEW OF THE ADEQUACY OF THE CONTRACTOR'S SAFETY MEASURES IN, ON, OR NEAR THE CONSTRUCTION SITE.
- D. ALL WATER AND SEWER IMPROVEMENTS SHALL BE CONSTRUCTED IN ACCORDANCE WITH THE LATEST REVISION TO THE CITY OF BRYANT'S WATER AND WASTEWATER (SANITARY SEWER) STANDARD SPECIFICATIONS.
- E. THE CONTRACTOR IS SPECIFICALLY CAUTIONED THAT THE LOCATION AND/OR ELEVATION OF EXISTING UTILITIES AS SHOWN ON THESE PLANS IS BASED ON RECORDS OF THE VARIOUS UTILITY COMPANIES AND, WHERE POSSIBLE, MEASUREMENTS TAKEN IN THE FIELD. THE INFORMATION IS NOT TO BE RELIED ON AS BEING EXACT OR COMPLETE. THE CONTRACTOR MUST CALL THE APPROPRIATE UTILITY COMPANY AT LEAST 48 HOURS BEFORE ANY EXCAVATION TO REQUEST EXACT FIELD LOCATION OF ALL UTILITIES. IT SHALL BE THE RESPONSIBILITY OF THE CONTRACTOR TO LOCATE ALL EXISTING UTILITIES WHICH CONFLICT WITH PROPOSED IMPROVEMENTS SHOWN ON THE PLAN.
- F. CONTRACTOR IS TO REMOVE AND DISPOSE OF ALL DEBRIS, RUBBISH, AND OTHER MATERIALS RESULTING FROM PREVIOUS AND CURRENT DEMOLITION OPERATIONS. DISPOSAL WILL BE IN ACCORDANCE WITH ALL LOCAL, STATE AND/OR FEDERAL REGULATIONS GOVERNING SUCH OPERATIONS.
- G. PRIOR TO INSTALLATION OF ANY UTILITIES, THE CONTRACTOR IS TO EXCAVATE, VERIFY AND CALCULATE ALL CROSSINGS AND INFORM ANY AND ALL UTILITIES OF ANY CONFLICTS PRIOR TO CONSTRUCTION.
- H. CONSTRUCTION SHALL NOT START ON ANY WATER UTILITY TIE-INS UNTIL APPROVAL IS GIVEN BY BRYANT UTILITIES. SAID CONTRACTOR SHALL NOT OPERATE ANY VALVE, HYDRANT, OR WATER UTILITY APPURTENANCE NOR SHALL HE ATTACH TO OR TAP ANY WATER UTILITY MAIN WITHOUT APPROVAL. THE CONTRACTOR SHALL BEAR THE COST AND CONSEQUENCE OF ANY DISRUPTION OF UTILITY OPERATION CAUSED BY CONSTRUCTION.
- I. FIBER OPTIC CABLE ON AND/OR ADJACENT TO THIS SITE WERE NOT LOCATED BY THE SURVEY AND ARE NOT SHOWN. IT IS THE RESPONSIBILITY OF THE CONTRACTOR TO LOCATE ANY FIBER OPTIC CABLES ASSOCIATED WITH THIS SITE AND TAKE ALL NECESSARY AND REQUIRED PRECAUTIONS TO PROTECT ANY EXISTING FIBER OPTIC CABLES. CONTRACTORS SHALL COORDINATE ALL EFFORTS WITH OWNER OF FIBER OPTIC CABLES OR THEIR DESIGNATED REPRESENTATIVE.
- J. THE CONTRACTOR IS RESPONSIBLE FOR CONTACTING "ONECALL" SERVICE TO MARK ALL UTILITIES PRIOR TO ANY DEMOLITION, EARTHWORK, OR UTILITY WORK ON THIS SITE.

PHILLIP LEWIS ENGINEERING, INC.
Structural + Civil Consultants
23620 Interstate 30 | Bryant, Arkansas
PH: 501-350-9840

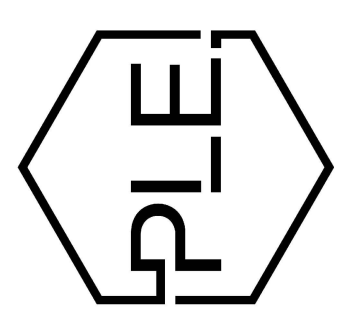

REVISION:

REVISION:

SPRINGHILL RETAIL
BRYANT, ARKANSAS

PROJECT NUMBER:
SHEET ISSUE DATE: 05-22-2024
PAGE TITLE: UTILITY PLAN

SHEET NUMBER: C1.4

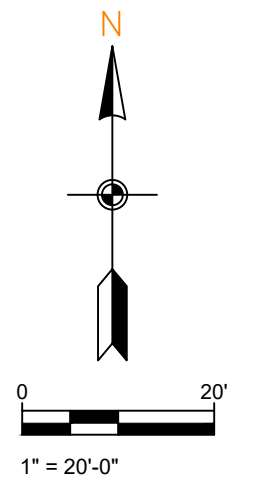

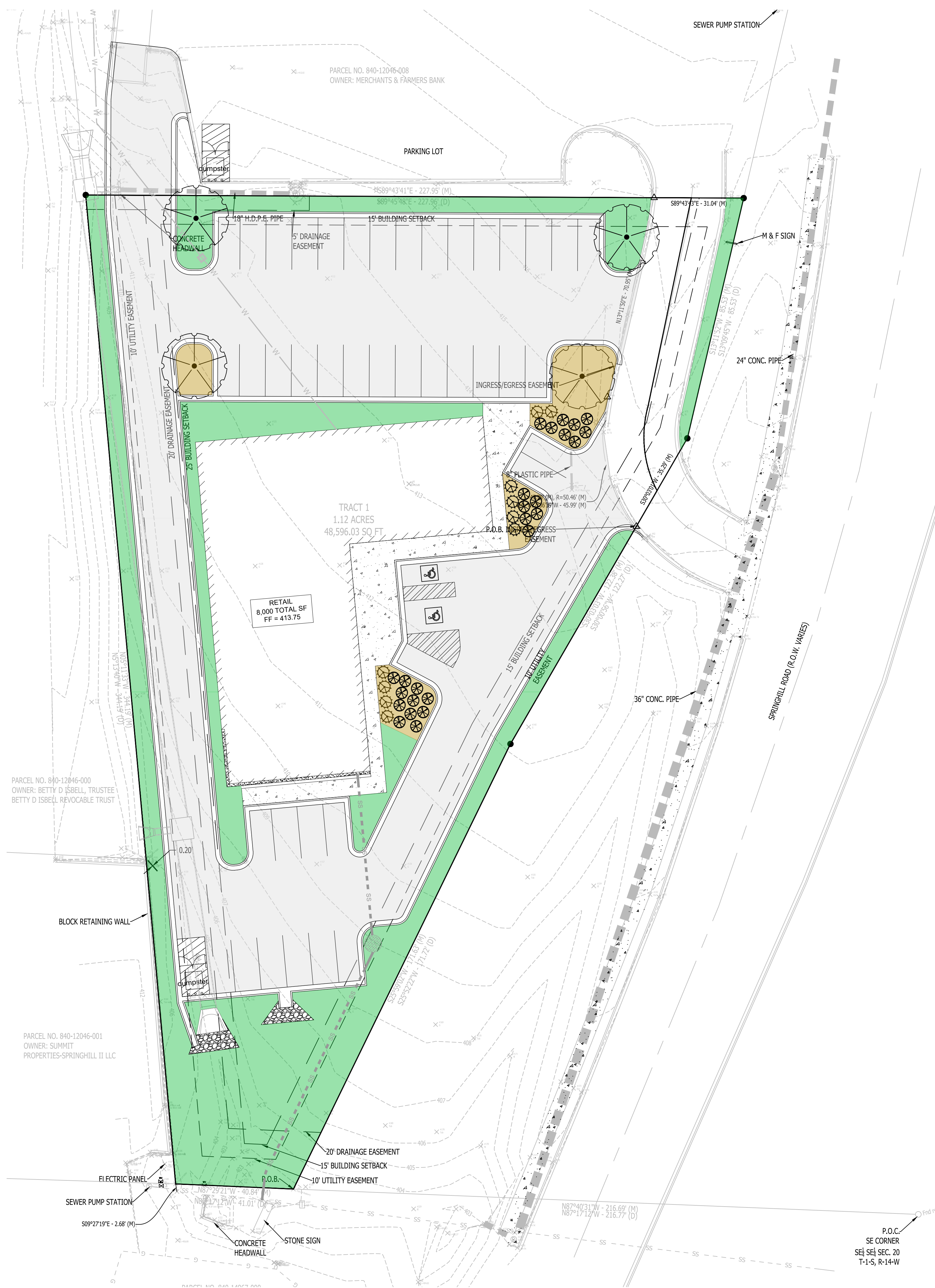

LANDSCAPE PLAN

SCALE 1" = 20'

GENERAL LANDSCAPING NOTES

1. ALL LANDSCAPED AREAS OF THE SITE SHALL BE CONSTRUCTED WITH AN AUTOMATIC SPRINKLER IRRIGATION SYSTEM AS PART OF THE LANDSCAPING SUBCONTRACT.
2. GENERAL CONTRACTOR SHALL PROVIDE SCHEDULE 40 PVC SLEEVING 4" OR 6" UNDER ALL DRIVES AND PAVED AREAS FOR IRRIGATION SLEEVING SHALL BE BURIED A MINIMUM OF 18" BELOW GRADE AND THE ENDS OF THE SLEEVES CLEARLY MARKED BY THE GENERAL CONTRACTOR AND SHALL EXTEND OUT A MINIMUM OF 18" PAST ANY CURB OR PAVING.
3. PROVIDE 3" DEPTH OF MULCH IN ALL LANDSCAPED ISLANDS AND BEDS LOCATED ALONG THE BUILDING.
4. PROVIDE 3" DEPTH OF MULCH AND METAL EDGING FOR LANDSCAPE NOT ADJACENT TO THE BUILDING.
5. LANDSCAPED AREAS TO BE AMENDED WITH 4" OF TOPSOIL. SCARIFY SOIL 3" PRIOR TO APPLICATION. ALL TOP SOIL SHALL BE PLACED IN COORDINATION WITH GRADING AND DRAINAGE PLANS TO ENSURE THAT THE GRADING AND DRAINAGE DESIGN FOR THE SITE IS MAINTAINED AFTER BEING SODDED OR SEEDED. EXISTING SOIL FROM THE SITE CAN BE STOCK PILED AND REUSED AS LONG AS IT IS OF QUALITY THAT ENCOURAGES ADEQUATE GROWTH OF PLANTING MATERIAL. THE CONTRACTOR IS RESPONSIBLE FOR ANY SOIL TESTING THAT MAY BE REQUIRED.
6. ALL DISTURBED AREAS ARE TO BE SODDED OR SEEDED, FERTILIZED, AND WATERED.

GENERAL CONSTRUCTION NOTES

- A. THE CONTRACTOR WILL BE HELD SOLELY RESPONSIBLE FOR DAMAGES OCCURRING TO ANY PROPERTY DURING THE CONSTRUCTION OF THIS PROJECT. SAID CONTRACTOR SHALL TAKE ALL NECESSARY PRECAUTIONS TO PREVENT PROPERTY DAMAGE.
- B. IN ACCORDANCE WITH GENERALLY ACCEPTED CONSTRUCTION PRACTICES, THE CONTRACTOR WILL SOLELY AND COMPLETELY BE RESPONSIBLE FOR CONDITIONS OF THE JOB SITE, INCLUDING SAFETY WORK. THIS REQUIREMENT WILL APPLY CONTINUOUSLY AND WILL NOT BE LIMITED TO NORMAL WORKING HOURS.
- C. THE DUTY OF BRYANT UTILITIES TO CONDUCT CONSTRUCTION INSPECTION REVIEWS OF THE CONTRACTOR'S PERFORMANCE IS NOT AN INSPECTION OR REVIEW OF THE ADEQUACY OF THE CONTRACTOR'S SAFETY MEASURES IN, ON, OR NEAR THE CONSTRUCTION SITE.
- D. ALL WATER AND SEWER IMPROVEMENTS SHALL BE CONSTRUCTED IN ACCORDANCE WITH THE LATEST REVISION TO THE CITY OF BRYANT'S WATER AND WASTEWATER (SANITARY SEWER) STANDARD SPECIFICATIONS.
- E. THE CONTRACTOR IS SPECIFICALLY CAUTIONED THAT THE LOCATION AND/OR ELEVATION OF EXISTING UTILITIES AS SHOWN ON THESE PLANS IS BASED ON RECORDS OF THE VARIOUS UTILITY COMPANIES AND, WHERE POSSIBLE, MEASUREMENTS TAKEN IN THE FIELD. THE INFORMATION IS NOT TO BE RELIED ON AS BEING EXACT OR COMPLETE. THE CONTRACTOR MUST CALL THE APPROPRIATE UTILITY COMPANY AT LEAST 48 HOURS BEFORE ANY EXCAVATION TO REQUEST EXACT FIELD LOCATION OF ALL UTILITIES. IT SHALL BE THE RESPONSIBILITY OF THE CONTRACTOR TO LOCATE ALL EXISTING UTILITIES WHICH CONFLICT WITH PROPOSED IMPROVEMENTS SHOWN ON THE PLAN.
- F. CONTRACTOR IS TO REMOVE AND DISPOSE OF ALL DEBRIS, RUBBISH, AND OTHER MATERIALS RESULTING FROM PREVIOUS AND CURRENT DEMOLITION OPERATIONS. DISPOSAL WILL BE IN ACCORDANCE WITH ALL LOCAL, STATE AND/OR FEDERAL REGULATIONS GOVERNING SUCH OPERATIONS.
- G. PRIOR TO INSTALLATION OF ANY UTILITIES, THE CONTRACTOR IS TO EXCAVATE, VERIFY AND CALCULATE ALL CROSSINGS AND INFORM ANY AND ALL UTILITIES OF ANY CONFLICTS PRIOR TO CONSTRUCTION.
- H. CONSTRUCTION SHALL NOT START ON ANY WATER UTILITY TIE-INS UNTIL APPROVAL IS GIVEN BY BRYANT UTILITIES. SAID CONTRACTOR SHALL NOT OPERATE ANY VALVE, HYDRANT, OR WATER UTILITY APPURTENANCE NOR SHALL HE ATTACH TO OR TAP ANY WATER UTILITY MAIN WITHOUT APPROVAL. THE CONTRACTOR SHALL BEAR THE COST AND CONSEQUENCE OF ANY DISRUPTION OF UTILITY OPERATION CAUSED BY CONSTRUCTION.
- I. FIBER OPTIC CABLE ON AND/OR ADJACENT TO THIS SITE WERE NOT LOCATED BY THE SURVEY AND ARE NOT SHOWN. IT IS THE RESPONSIBILITY OF THE CONTRACTOR TO LOCATE ANY FIBER OPTIC CABLES ASSOCIATED WITH THIS SITE AND TAKE ALL NECESSARY AND REQUIRED PRECAUTIONS TO PROTECT ANY EXISTING FIBER OPTIC CABLES. CONTRACTORS SHALL COORDINATE ALL EFFORTS WITH OWNER OF FIBER OPTIC CABLES OR THEIR DESIGNATED REPRESENTATIVE.
- J. THE CONTRACTOR IS RESPONSIBLE FOR CONTACTING "ONECALL" SERVICE TO MARK ALL UTILITIES PRIOR TO ANY DEMOLITION, EARTHWORK, OR UTILITY WORK ON THIS SITE.

PLANT SCHEDULE						
PLANT TYPE	SYMBOL	CODE	QTY	COMMON	SCIENTIFIC NAME	CAL / SIZE
TREES		WO	4	WILLOW OAK	QUERCUS PHELLOS	MIN. 3" DIAMETER @ BASE AND 12' TALL
SHRUBS		BW	10	BOXWOOD	BUSUS SEMPERVIRENS	5 GAL (MAX 30" TALL AT INSTALLATION)
GROUND COVER		DN	25	DWARF NANDINA	N. DOMESTICA "HARBOUR DWARF"	3 GAL
BEDDING		MU	1,530	MULCH		
GRASS		MU	10,035	BERMUDA		

PHILLIP LEWIS ENGINEERING, INC.
Structural + Civil Consultants
23620 Interstate 30 | Bryant, Arkansas
PH: 501-350-9840

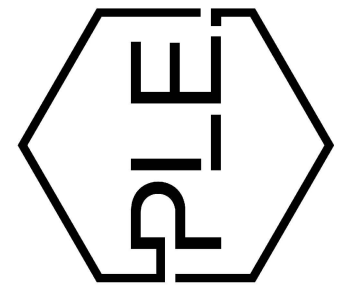

REVISION:

SPRINGHILL RETAIL
BRYANT, ARKANSAS

PROJECT NUMBER:

SHEET ISSUE DATE: 05-22-2024

PAGE TITLE:

LANDSCAPE PLAN

SHEET NUMBER:

C1.5

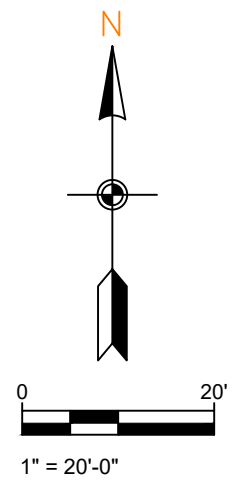

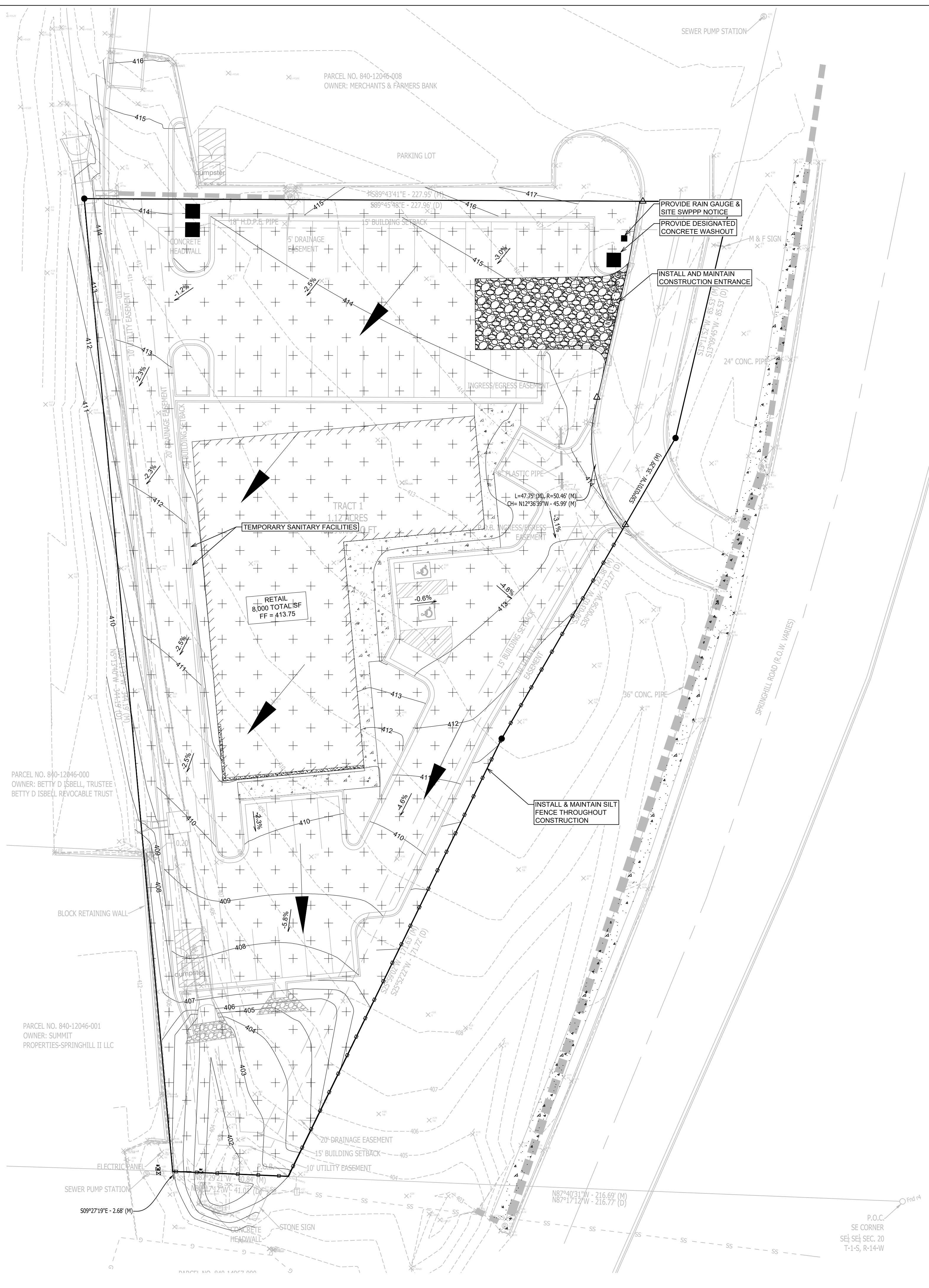

LEGEND

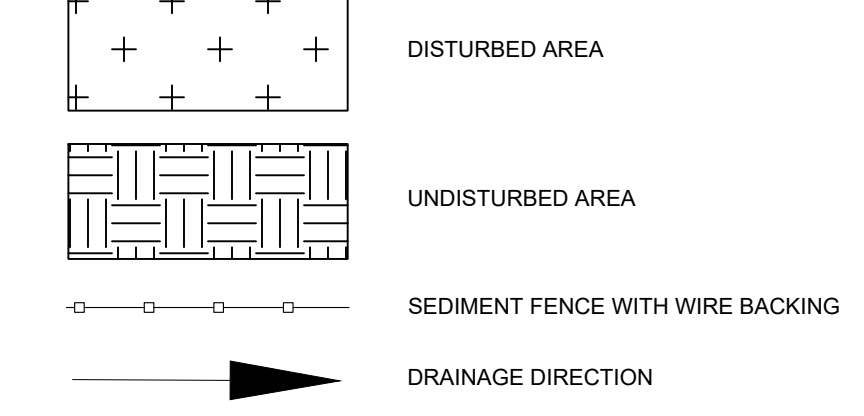

NOTES (GENERAL):

1. SEE EROSION CONTROL DETAILS IN SWPPP FOR EROSION CONTROL FACILITIES.
2. SEE SWPPP FOR INSTALLATION, MAINTENANCE, INSPECTION, AND RECORD KEEPING REQUIREMENTS.
3. CONTRACTOR SHALL SHOW EROSION CONTROL MEASURE ON SITE MAP.
4. EROSION AND SEDIMENT CONTROL STRUCTURES TO MEET SWPPP DETAILS - APPENDIX D
5. INSTALL ROCK DITCH, CHECK, OR SAND BAG CHECKS AS NECESSARY TO PREVENT SCOUR UNTIL LANDSCAPING IS ESTABLISHED.
6. CONTRACTOR MUST PLACE SEDIMENT BASIN WITH SEDIMENT FENCE OUTLET FOR ANY SEDIMENT CONTAMINATED DEWATERING DISCHARGE.
7. FINAL SLOPE WILL BE SAME DIRECTION AS EXISTING SLOPE.
8. TEMPORARY STABILIZATION PRACTICES WILL NOT BE REQUIRED. WORK WILL BE CONTINUOUS AND DISTURBED AREA REVEGETATED IN A TIMELY MANNER. SEE SWPPP FOR SEEDING MIXES.
9. PERMANENT STABILIZATION OF ALL DISTURBED AREAS ARE TO BE SEEDED, FERTILIZED, WATERED AND COVERED WITH STRAW UNLESS OTHERWISE NOTED ON PLANS TO BE HYDROSEEDING.
10. CONTRACTOR TO SHOW CONCRETE WASH OUT SUMP, ENTRANCE/EXIT PAD AND OTHER CONTROLS AS REQUIRED/NEEDED AS SWPPP SITE MAP IS UPDATED THROUGHOUT THE DURATION OF THE PROJECT.
11. STOCKPILING OF CONSTRUCTION SPOIL MATERIAL AT PARTICULAR LOCATIONS SHALL ONLY BE ALLOWED FOR A LIMITED TIME PERIOD, NOT TO EXCEED (6) MONTHS. PRIOR TO A FINAL INSPECTION OF THE GRADING PERMIT, THE FOLLOWING STANDARDS SHALL BE ACHIEVED FOR COMPLETION OF CONSTRUCTION:
 - a) DEVELOPMENT AND GRADING WITHIN THE DISTURBED AREA IS COMPLETE AND MATCHES PLANS AS APPROVED BY THE PLANNING COMMISSION, AND
 - b) THE DISTURBED SOIL AREA IS OBSERVED TO HAVE 80% GRASS COVERAGE AND 100% STABILITY, AND
 - c) NO SLOPES STEEPER THAN A 3:1 PITCH UNLESS OTHERWISE APPROVED IN WRITING BY THE DIRECTOR OF ENGINEERING, AND
 - d) NOTICE OF VIOLATIONS ISSUED HAVE ALL CORRECTIVE ACTIONS APPROVED WITH AN INSPECTION REPORT SIGNED BY A REPRESENTATIVE OF THE DIRECTOR OF ENGINEERING, AND
 - e) ALL HEAVY EQUIPMENT, STOCKPILES, AND CONSTRUCTION SITE MATERIALS HAVE BEEN REMOVED FROM THE CONSTRUCTION SITE.

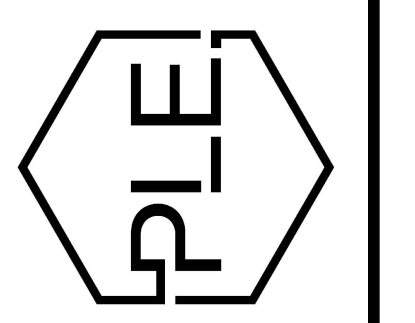

REVISION:

SPRINGHILL RETAIL
BRYANT, ARKANSAS

PROJECT NUMBER:

SHEET ISSUE DATE: 05-22-2024

PAGE TITLE: SWPPP

SHEET NUMBER: C1.6

SWPPP

SCALE 1" = 20'

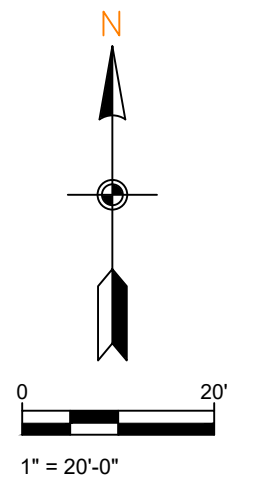



OVERALL DRAINAGE MAP

SCALE 1" = 80'

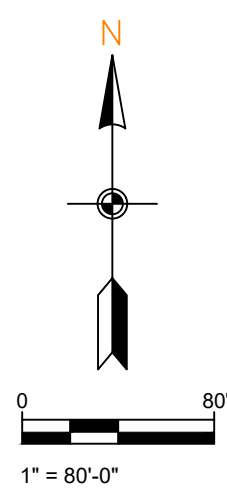

REVISION:

SPRINGHILL RETAIL
BRYANT, ARKANSAS

PROJECT NUMBER:
SHEET ISSUE DATE: 05-22-2024
PAGE TITLE:

OVERALL DRAINAGE MAP
SHEET NUMBER: **C1.7**



2 3D View-EXTERIOR END-1



5 3D - EXTERIOR FRONT-8

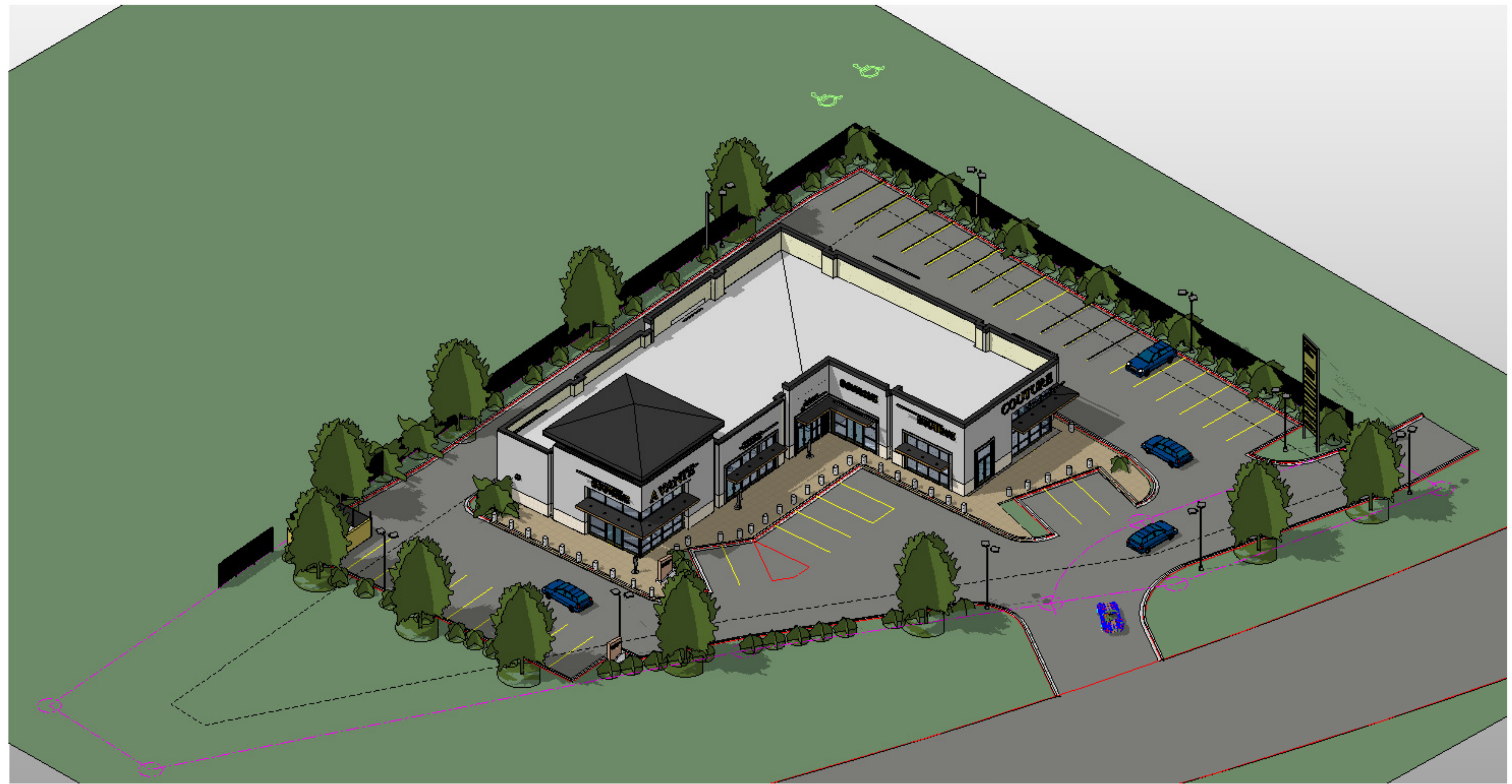

1 3D-VIEW-EXTERIOR FROM ABOVE FRONT

6 Section 3
1/8" = 1'-0"

ENGINEERING DOCUMENTS FOR DETAILED GRADING AND DRAINAGE OF THIS AREA OF THE SITE WILL BE SUBMITTED BY ARKANSAS REGISTERED CIVIL ENGINEERS.

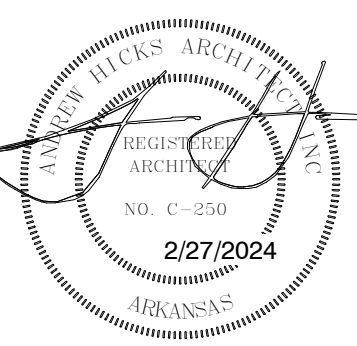

ARCHITECT OF RECORD
ANDREW F. HICKS

A NEW PROPOSED COMMERCIAL DEVELOPMENT

FOR
SUMMERWOOD PARTNERS
HWY 5 AND SPRINGHILL AREA
BRYANT, ARKANSAS

andrew hicks | architect
AHFA
601.880.0789
601.332.9550
www.andrewhicksarchitect.com
600 N Mission Blvd.
Fayetteville, Arkansas 72701

ISSUE DATE: 2/27/2024

REVISIONS	
NO.	DATE

SITE VIEWS - AERIAL

AC101



1 3D-VIEW-EXTERIOR FRONT-HIGH VIEW



2 3D View-EXTERIOR FRONT-1



3 3D View-EXTERIOR FRONT-5

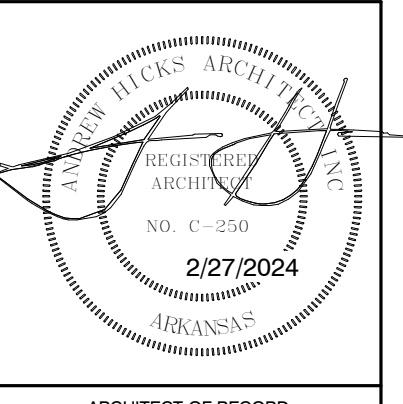

ARCHITECT OF RECORD
ANDREW F. HICKS

A NEW PROPOSED COMMERCIAL DEVELOPMENT

FOR
SUMMERWOOD PARTNERS
HWY 5 AND SPRINGHILL AREA
BRYANT, ARKANSAS

andrew hicks | architect
AHFA
601-880-0789
600 N Mission Blvd.
Fayetteville, Arkansas 72701
www.andrewhicksarchitect.com

ISSUE DATE: 2/27/2024

REVISIONS	
NO.	DATE

SITE 3D VIEWS

AC102



1 3D View-EXTERIOR FRONT-3



6 3D View-EXTERIOR FRONT-2



2 3D VIEW-EXTERIOR REAR-2



3 3D View 3 -NIGHT



SOUTH ELEVATION-SPRING HILL CENTER
4 3/32" = 1'-0"

ENGINEERING DOCUMENTS FOR DETAILED GRADING AND DRAINAGE OF THIS AREA OF THE SITE WILL BE SUBMITTED BY ARKANSAS REGISTERED CIVIL ENGINEERS.

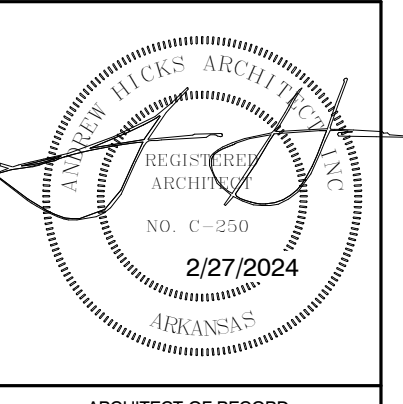

ARCHITECT OF RECORD
ANDREW F. HICKS

A NEW PROPOSED COMMERCIAL DEVELOPMENT

FOR
SUMMERWOOD PARTNERS
HWY 5 AND SPRINGHILL AREA
BRYANT, ARKANSAS

andrew hicks | architect
AFA
601-880-0789
601-832-0550
www.andrewhicksarchitect.com
600 N Mission Blvd.
Fayetteville, Arkansas 72701

ISSUE DATE: 2/27/2024

REVISIONS	
NO.	DATE

SITE 3D VIEWS

AC103