

# SITE WITH AUTOMATIC COVERAGE (LESS THAN 5 ACRES) CONSTRUCTION SITE NOTICE

FOR THE  
Arkansas Department of Environmental Quality (ADEQ)  
Storm Water Program  
**NPDES GENERAL PERMIT NO. ARR150000**

The following information is posted in compliance with **Part I.B.8.A** of the ADEQ General Permit Number **ARR150000** for discharges of stormwater runoff from sites with automatic coverage. Additional information regarding the ADEQ stormwater program may be found on the internet at:

[www.adeg.state.ar.us/water/branch\\_npdes/stormwater](http://www.adeg.state.ar.us/water/branch_npdes/stormwater)

Permit Number	ARR150000
Contact Name: Phone Number:	Michael Butler 870-703-3807
Project Description (Name, Location, etc.): Start Date: End Date: Total Acres:	New Facility for Butler Center, Boyant, AR   1.69
Location of Stormwater Pollution Prevention Plan:	Mailbox on Site

For Construction Sites Authorized under **Part I.B.6.A** (Automatic Coverage) the following certification must be completed:

I \_\_\_\_\_ (Typed or Printed Name of Person Completing this Certification) certify under penalty of law that I have read and understand the eligibility requirements for claiming an authorization under Part I.B.2. of the ADEQ General Permit Number ARR150000. A stormwater pollution prevention plan has been developed and implemented according to the requirements contained in Part II.A.2.B & D of the permit. I am aware there are significant penalties for providing false information or for conducted unauthorized discharges, including the possibility of fine and imprisonment for knowing violations.

\_\_\_\_\_  
Signature and Title

\_\_\_\_\_  
Date

Stormwater Pollution Prevention Plan (SWPPP) for Construction Activity  
for Small Construction Sites

National Pollutant Discharge Elimination System (NPDES)  
General Permit # ARR150000

Prepared for:  
New Facility For  
Butler Center

Date:  
03/17/2023

Prepared by:  
GarNat Engineering, LLC

**Table of Contents**  
**New Facility for: Butler Center**  
**Bryant, Arkansas**

SWPPP for Construction Activity for Small Construction Sites

Appendix A- ARR150000 Inspection Form

SWPPP Figures

New Facility for: Butler Center Erosion Control Plan

AHTD Standard Drawings:

TEC-1 – Temporary Erosion Control Devices

TEC-4 – Temporary Erosion Control Devices

NPDES ARR150000

Project Name and Location: New Facility for Butler Center, 1109 N Reynolds Rd, Bryant, AR.

Property Parcel Number (Optional): 840-14297-000

Operator Name and Address: \_\_\_\_\_

A. Site Description

- a. Project description, intended use after NOI is filed: Commercial development of a Chiropractic Clinic and parking lot.
- b. Sequence of major activities which disturb soils: clearing & grubbing, earthwork, drainage structure, utilities
- c. Total Area: 1.69 Ac. Disturbed Area: 1.51 Ac.

B. Responsible Parties

*Be sure to assign all SWPPP related activities to an individual or position; even if the specific individual is not yet known (i.e. contractor has not been chosen).*

Individual/Company	Phone Number	Service Provided for SWPPP (i.e., Inspector, SWPPP revisions, Stabilization Activities, BMP Maintenance, etc.)
<u>Michael Butler</u>	<u>870-703-3807</u>	

C. Receiving Waters

- a. The following waterbody (or waterbodies) receives stormwater from this construction site: Unnamed tributaries of Hurricane Creek
- b. Is the project located within the jurisdiction of an MS4?  Yes  No
  - i. If yes, Name of MS4: Bryant
- c. Ultimate Receiving Water:
 

<input type="checkbox"/> Red River	<input type="checkbox"/> White River
<input type="checkbox"/> Ouachita River	<input type="checkbox"/> St. Francis River
<input checked="" type="checkbox"/> Arkansas River	<input type="checkbox"/> Mississippi River

D. Site Map Requirements (Attach Site Map):

- a. Pre-construction topographic view;

- b. Direction of stormwater flow (i.e., use arrows to show which direction stormwater will flow) and approximate slopes anticipated after grading activities;
- c. Delineate on the site map areas of soil disturbance and areas that will not be disturbed under the coverage of this permit;
- d. Location of major structural and nonstructural controls identified in the plan;
- e. Location of main construction entrance and exit;
- f. Location where stabilization practices are expected to occur;
- g. Locations of off-site materials, waste, borrow area, or equipment storage area;
- h. Location of areas used for concrete wash-out;
- i. Location of all surface water bodies (including wetlands) with associated natural buffer boundary lines. Identify floodplain and floodway boundaries, if available;
- j. Locations where stormwater is discharged to a surface water and/or municipal separate storm sewer system if applicable,
- k. Locations where stormwater is discharged off-site (should be continuously updated);
- l. Areas where final stabilization has been accomplished and no further construction phase permit requirements apply;
- m. A legend that identifies any erosion and sediment control measure symbols/labels used in the site map and/or detail sheet; and
- n. Locations of any storm drain inlets on the site and in the immediate vicinity of the site.

E. Stormwater Controls

- a. Initial Site Stabilization, Erosion and Sediment Controls, and Best Management Practices:

- i. Initial Site Stabilization: Prior to starting clearing activities, the BMP's shown on the Erosion Control Plan will be installed.
- ii. Erosion and Sediment Controls: Erosion and sediment controls are shown on the erosion control plan, they will be constructed per AHJD standard details
- iii. If periodic inspections or other information indicates a control has been used inappropriately or incorrectly, the operator will replace or modify the control for site situations:  Yes  No  
If No, explain: \_\_\_\_\_  
\_\_\_\_\_
- iv. Off-site accumulations of sediment will be removed at a frequency sufficient to minimize off-site impacts:  Yes  No

If No, explain: \_\_\_\_\_  
\_\_\_\_\_

- v. Sediment will be removed from sediment traps or sedimentation ponds when design capacity has been reduced by 50%:  Yes  No

If No, explain: \_\_\_\_\_  
\_\_\_\_\_

- vi. Litter, construction debris, and construction chemicals exposed to stormwater shall be prevented from becoming a pollutant source for stormwater discharges:  Yes  No

If No, explain: \_\_\_\_\_  
\_\_\_\_\_

- vii. Off-site material storage areas used solely by the permitted project are being covered by this SWPPP:  Yes  No (There are no such sites)

If Yes, explain additional BMPs implemented at off-site material storage area: \_\_\_\_\_  
\_\_\_\_\_

b. Stabilization Practices

- i. Description and Schedule: As soon as practical, the contractor will spread topsoil and seed the disturbed area with a perennial vegetation. Vegetation will be reseeded as required to establish the 80% coverage of perennial vegetation.

- ii. Are buffer areas required?  Yes  No

If Yes, are buffer areas being used?  Yes  No

If No, explain why not: \_\_\_\_\_  
\_\_\_\_\_

If Yes, describe natural buffer areas: \_\_\_\_\_  
\_\_\_\_\_

- iii. A record of the dates when grading activities occur, when construction activities temporarily or permanently cease on a portion of the site, and when stabilization measures are initiated shall be included with the plan.

Yes  No

If No, explain: \_\_\_\_\_  
\_\_\_\_\_

- iv. Deadlines for stabilization:

1. Stabilization procedures will be initiated 14 days after construction activity temporarily ceases on a portion of the site.
2. Stabilization procedures will be initiated immediately in portions of the site where construction activities have permanently ceased.

c. Structural Practices

i. Describe any structural practices to divert flows from exposed soils, store flows, or otherwise limit runoff and the discharge of pollutants from exposed areas of the site: BMPs shown on the erosion control plan will be used to limit sediment from leaving the site

ii. Describe Velocity Dissipation Devices: \_\_\_\_\_

iii. Sediment Basins:

Are 10 or more acres draining to a common point?  Yes  No

Is a sediment basin included in the project?  Yes  No

If Yes, what is the designed capacity for the storage?

3600 cubic feet per acre = : \_\_\_\_\_

or

10 year, 24 hour storm = : \_\_\_\_\_

Other criteria were used to design basin: \_\_\_\_\_

If No, explain why no sedimentation basin was included and describe required natural buffer areas and other controls implemented instead: Not appropriate for this project.

F. Other Controls

a. Solid materials, including building materials, shall be prevented from being discharged to Waters of the State:  Yes  No

b. Off-site vehicle tracking of sediments and the generation of dust shall be minimized through the use of:

A stabilized construction entrance and exit

Vehicle tire washing

Other controls, describe: \* see below

c. Temporary Sanitary Facilities: A portable toilet will be provided. The location is shown on the Erosion control Plan.

\* The road adjacent to the property will be swept to remove offside vehicle tracks. Disturbed areas will be watered during construction.

d. Concrete Waste Area Provided:

Yes

No. Concrete is used on the site, but no concrete washout is provided.

Explain why: \_\_\_\_\_

N/A, no concrete will be used with this project

e. Fuel Storage Areas, Hazardous Waste Storage, and Truck Wash Areas: \_\_\_\_\_

G. Non-Stormwater Discharges

a. The following allowable non-stormwater discharges comingled with stormwater are present or anticipated at the site:

Fire-fighting activities;

Fire hydrant flushings;

Water used to wash vehicles (where detergents or other chemicals are not used) or control dust in accordance with Part II.A.4.H.2;

Potable water sources including uncontaminated waterline flushings;

Landscape Irrigation;

Routine external building wash down which does not use detergents or other chemicals;

Pavement wash waters where spills or leaks of toxic or hazardous materials have not occurred (unless all spilled materials have been removed) and where detergents or other chemicals are not used;

Uncontaminated air conditioning, compressor condensate (See Part I.B.12.C of the permit);,

Uncontaminated springs, excavation dewatering and groundwater (See Part I.B.13.C of the permit);

Foundation or footing drains where flows are not contaminated with process materials such as solvents (See Part I.B.13.C of the permit);

b. Describe any controls associated with non-stormwater discharges present at the site:

*BMP's shown on the Erosion Control plan will also be utilized to prevent sedimentation from leaving site during construction.*

H. Applicable State or Local Programs: The SWPPP will be updated as necessary to reflect any revisions to applicable federal, state, or local requirements that affect the stormwater controls implemented at the site.  Yes  No

I. Inspections

a. Inspection frequency:

Every 7 calendar days

or

At least once every 14 calendar days and within 24 hours of the end of a storm even 0.25 inches or greater (a rain gauge must be maintained on-site)



b. Inspections:

Completed inspection forms will be kept with the SWPPP.

ADEQ's inspection form will be used (See Appendix B)

or

A form other than ADEQ's inspection form will be used and is attached  
(See inspection form requirements Part II.A.4.L.2)

c. Inspection records will be retained as part of the SWPPP for at least 3 years from the date of termination.

d. It is understood that the following sections describe waivers of site inspection requirements. All applicable documentation requirements will be followed in accordance with the referenced sections.

- i. Winter Conditions (Part II.A.4.L.4)
- ii. Adverse Weather Conditions (Part II.A.4.L.5)

J. Maintenance:

The following procedures to maintain vegetation, erosion and sediment control measures and other protective measures in good, effective operating condition will be followed: see below\*

Any necessary repairs will be completed, when practicable, before the next storm event, but not to exceed a period of 3 business days of discovery, or as otherwise directed by state or local officials.

K. Employee Training:

The following is a description of the training plan for personnel (including contractors and subcontractors) on this project: Operator will submit proof of training to engineer. Engineer will provide additional training as required to ensure that SWPPP is properly implemented.

\*\*Note, Formal training classes given by Universities or other third-party organizations are not required, but recommended for qualified trainers; the permittee is responsible for the content of the training being adequate for personnel to implement the requirements of the permit.

\* Built up sediment will be removed from silt fencing when it has reached 1/3 of the height of the fence. Silt fences will be inspected for the depth of sediment, tears, fabric attachment to the fence posts, and to see that the fence posts are firmly in the ground. Temporary and permanent seeding will be inspected for bare spots, washouts, and healthy growth. Entrance will be inspected for sediment tracked on roads.

Certification

"I certify under penalty of law that this document and all attachments such as Inspection Form were prepared under my direction or supervision in accordance with a system designed to ensure that qualified personnel properly gather and evaluate the information submitted. Based on my inquiry of the person or persons who manage the system, or those persons directly responsible for gathering the information, the information submitted is, to the best of my knowledge and belief, true, accurate, and complete. I am aware that there are significant penalties for submitting false information, including the possibility of fine and imprisonment for knowing violations."

Signature of Responsible or Cognizant Official: \_\_\_\_\_

Title: \_\_\_\_\_

Date: \_\_\_\_\_

**ARR150000 Inspection Form**

Appendix A

Inspector Name: \_\_\_\_\_

Date of Inspection: \_\_\_\_\_

Inspector Title: \_\_\_\_\_

Date of Rainfall: \_\_\_\_\_

Duration of Rainfall: \_\_\_\_\_

Days Since Last Rain Event: \_\_\_\_\_ days

Rainfall Since Last Rain Event: \_\_\_\_\_ inches

Description of any Discharges During Inspection: \_\_\_\_\_

Location of Discharges of Sediment/Other Pollutant (specify pollutant & location): \_\_\_\_\_

Locations in Need of Additional BMPs: \_\_\_\_\_

**Information on Location of Construction Activities**

Location	Activity Begin Date	Activity Occuring Now (y/n)?	Activity Ceased Date	Stabilization Initiated Date	Stabilization Complete Date

**Information on BMPs in Need of Maintenance**

Location	In Working Order?	Maintenance Scheduled Date	Maintenance Completed Date	Maintenance to be Performed By

Changes required to the SWPPP: \_\_\_\_\_

Reasons for changes: \_\_\_\_\_

\_\_\_\_\_

\_\_\_\_\_

SWPPP changes completed (date): \_\_\_\_\_

"I certify under penalty of law that this document and all attachments such as Inspection Form were prepared under my direction or supervision in accordance with a system designed to ensure that qualified personnel properly gather and evaluate the information submitted. Based on my inquiry of the person or persons who manage the system, or those persons directly responsible for gathering the information, the information submitted is, to the best of my knowledge and belief, true, accurate, and complete. I am aware that there are significant penalties for submitting false information, including the possibility of fine and imprisonment for knowing violations."

Signature of Responsible or Cognizant Official: \_\_\_\_\_ Date: \_\_\_\_\_

Title: \_\_\_\_\_

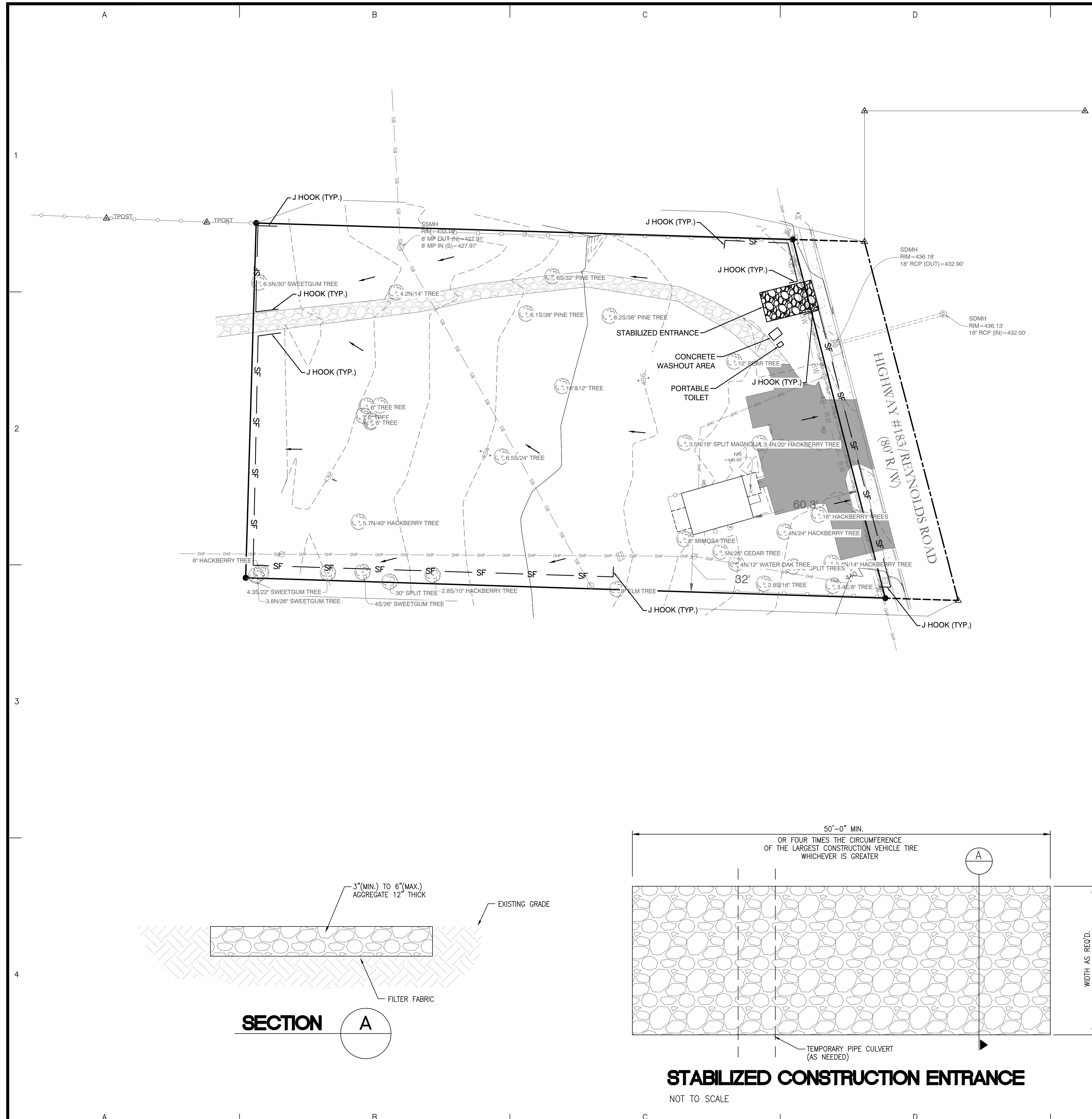

- BMP NOTES:**
- ALL WASH WATER (CONCRETE TRUCKS, VEHICLE CLEANING, EQUIPMENT CLEANING, ETC.) SHALL BE DETAINED AND PROPERLY TREATED OR DISPOSED.
  - DUST ON THE SITE SHALL BE CONTROLLED. THE USE OF MOTOR OILS AND OTHER PETROLEUM BASED OR TOXIC LIQUIDS FOR DUST SUPPRESSION OPERATIONS IS PROHIBITED.
  - RUBBISH, TRASH, GARBAGE, LITTER, OR OTHER SUCH MATERIALS SHALL BE DEPOSITED INTO SEALED CONTAINERS. MATERIAL SHALL BE PREVENTED FROM LEAVING THE PREMISES THROUGH THE ACTION OF WIND OR STORMWATER DISCHARGE INTO DRAINAGE DITCHES OR WATERS OF THE STATE.
  - DISTURBED PORTIONS OF THE SITE WHERE CONSTRUCTION ACTIVITY HAS STOPPED FOR AT LEAST 14 DAYS, SHALL BE TEMPORARILY SEEDED. THESE AREAS SHALL BE SEEDED NO LATER THAN 14 DAYS FROM THE LAST CONSTRUCTION ACTIVITY OCCURRING IN THESE AREAS.
  - DISTURBED PORTIONS OF THE SITE WHERE CONSTRUCTION ACTIVITY HAS PERMANENTLY STOPPED SHALL BE PERMANENTLY SEEDED. THESE AREAS SHALL BE SEEDED NO LATER THAN 14 DAYS AFTER THE LAST CONSTRUCTION ACTIVITY OCCURRING IN THESE AREAS. REFER TO THE GRADING PLAN AND/OR LANDSCAPE PLAN.
  - IF THE ACTION OF VEHICLES TRAVELING OVER THE SITE IS NOT SUFFICIENT TO REMOVE THE MAJORITY OF DIRT OR MUD, THEN THE TIRES MUST BE WASHED BEFORE THE VEHICLES ENTER A PUBLIC ROAD. IF WASHING IS USED, PROVISIONS MUST BE MADE TO INTERCEPT THE WASH WATER AND TRAP THE SEDIMENT BEFORE IT IS CARRIED OFF OF THE SITE.
  - ALL MATERIALS SPILLED, DROPPED, WASHED OR TRACKED FROM VEHICLES ONTO ROADWAYS OR INTO STORM DRAINS MUST BE REMOVED IMMEDIATELY.
  - CONTRACTORS OR SUBCONTRACTORS WILL BE RESPONSIBLE FOR REMOVING SEDIMENT IN THE DETENTION POND AND ANY SEDIMENT THAT MAY HAVE COLLECTED IN THE STORM SEWER DRAINAGE SYSTEMS IN CONJUNCTION WITH THE STABILIZATION OF THE SITE.
  - ON-SITE & OFF SITE SOIL STOCKPILE AND BORROW AREAS SHALL BE PROTECTED FROM EROSION AND SEDIMENTATION THROUGH IMPLEMENTATION OF BEST MANAGEMENT PRACTICES. STOCKPILE AND BORROW AREA LOCATIONS SHALL BE NOTED ON THE SITE MAP AND PERMITTED IN ACCORDANCE WITH GENERAL PERMIT REQUIREMENTS.
  - ALL CONSTRUCTION SHALL BE STABILIZED AT THE END OF EACH WORKING DAY. THIS INCLUDES BACKFILLING OF TRENCHES FOR UTILITY CONSTRUCTION AND PLACEMENT OF GRAVEL OR BITUMINOUS PAVING FOR ROAD CONSTRUCTION.

TOTAL SITE: 1.69 ACRES (INCLUDES R-O-W)  
 TOTAL DISTURBED AREA: 1.51 ACRES (INCLUDES R-O-W)

- LEGEND:**
- 500 — EXISTING CONTOURS
  - DIRECTION OF OVERLAND FLOW
  - SF — SILT FENCING

BY	
REVISION	
DATE	
<p><b>Designing our client's success</b></p> <p><b>GarNat Engineering, LLC</b>        3825 Mt Carmel Rd        Bryant, AR 72022        garnatengineering@gmail.com</p> <p><b>NEW FACILITY FOR:        BUTLER CENTER        CITY OF BRYANT, AR</b></p>	
<p>03-06-2023</p>	
<p>CONTENTS:</p> <p><b>EROSION CONTROL PLAN</b></p>	
<p>PROJECT NO: 22203</p>	
<p>DATE: FEB 2023</p>	
<p>SHEET NO: <b>C4.0</b></p>	

A:\Projects\2022 Projects\22203 Butler Center 1108 North Reynolds Road Kerry Willard\Drawings\22203\_1108\_N\_Reynolds\_Rd.dwg

GENERAL NOTES

INSTALL A MINIMUM OF 2 UPSLOPE STAKES AND 4 DOWNSLOPE STAKES AT AN ANGLE TO WEDGE WATTLE TO BOTTOM OF DITCH.

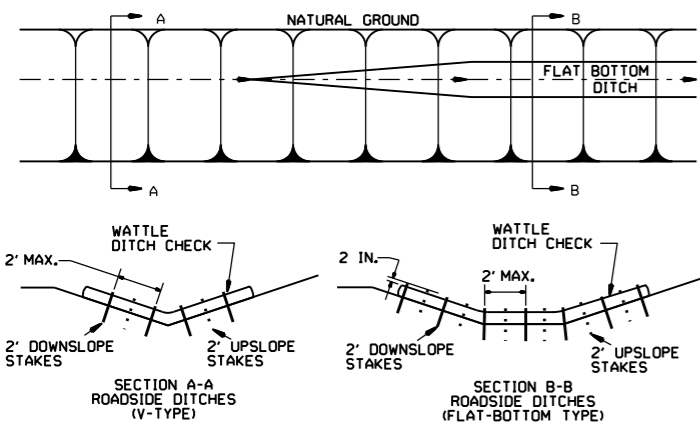

WATTLE DITCH CHECK (E-1)

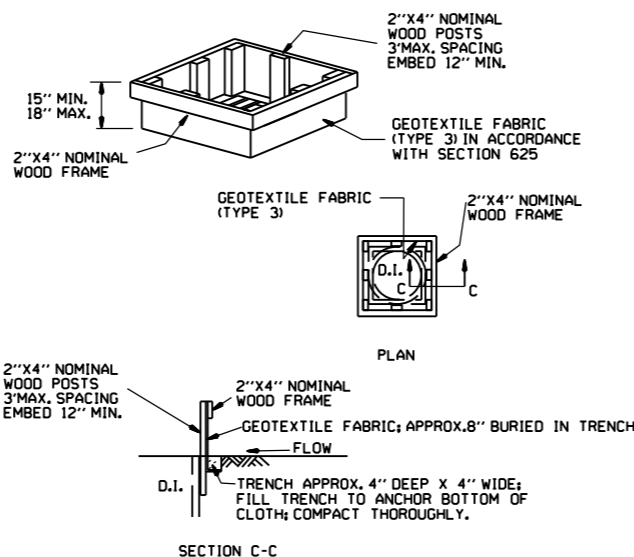

DROP INLET SILT FENCE (E-7)

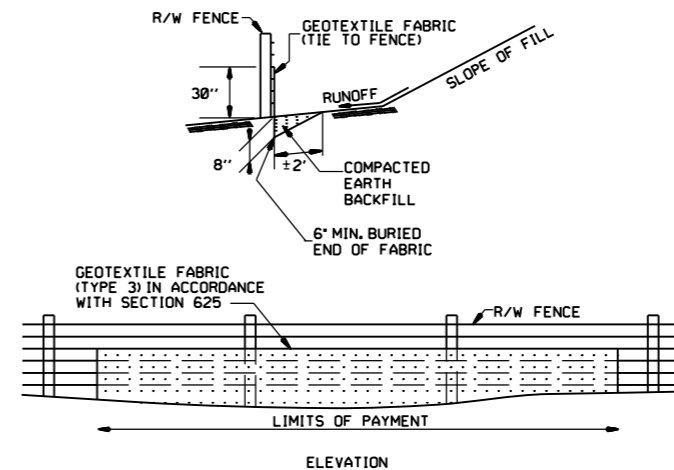

SILT FENCE ON R/W FENCE (E-4)

GENERAL NOTES  
 GEOTEXTILE FABRIC SHALL BE SPLICED TOGETHER WITH A SEWN SEAM ONLY AT A SUPPORT POST, OR TWO SECTIONS OF FENCE MAY BE OVERLAPPED INSTEAD. PAYMENT OF ADDITIONAL MATERIAL FOR OVERLAP WILL NOT BE MADE.

- GENERAL NOTES
1. STRAW BALES SHALL BE INSTALLED SO THAT THE BINDINGS ARE ORIENTED AROUND THE SIDES RATHER THAN ALONG THE TOPS AND BOTTOMS OF THE BALES. THE BALES SHALL BE A MINIMUM OF 30 INCHES IN LENGTH.
  2. NO GAPS SHALL BE LEFT BETWEEN BALES.
  3. BALED STRAW FILTER BARRIERS COMPLETED AND ACCEPTED WILL BE MEASURED BY THE BALE IN PLACE AS AUTHORIZED BY THE ENGINEER AND WILL BE PAID FOR AT THE CONTRACT UNIT PRICE BID PER BALE FOR BALED STRAW DITCH CHECKS.

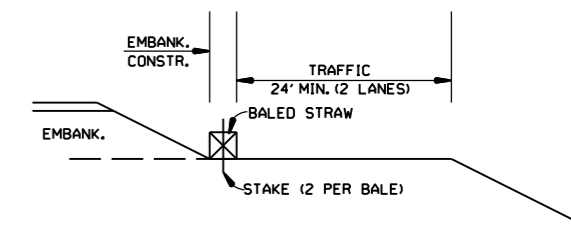

BALED STRAW FILTER BARRIER (E-2)

NUMBER OF SAND BAGS AND ARRANGEMENT VARIABLE WITH ON-SITE CONDITIONS. PLACE SAND BAGS AT BASE OF DITCH CHECK IN AREA OF OVERFLOW

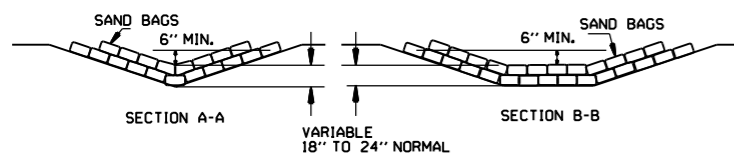

SAND BAG DITCH CHECK (E-5)

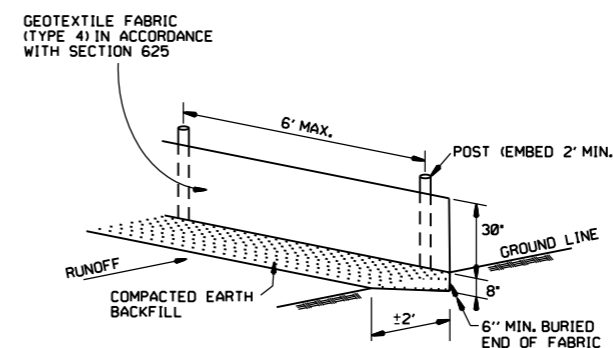

SILT FENCE (E-11)

GENERAL NOTES  
 GEOTEXTILE FABRIC SHALL BE SPLICED TOGETHER WITH A SEWN SEAM ONLY AT A SUPPORT POST OR TWO SECTIONS OF FENCE MAY BE OVERLAPPED INSTEAD. PAYMENT OF ADDITIONAL MATERIAL FOR OVERLAP WILL NOT BE MADE.

PER CITY OF BRYANT REQUIREMENTS, REQUIRES WIRED BACK FENCE.

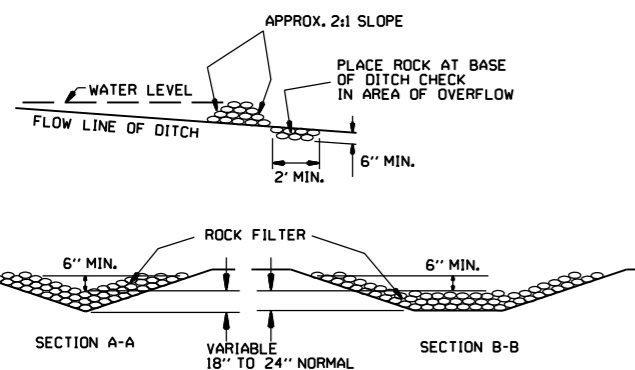

ROCK DITCH CHECK (E-6)

12-15-11	DELETED BALED STRAW DITCH CHECK & ADDED WATTLE DITCH CHECK	
11-18-98	ADDED NOTES	
7-02-98	ADDED BALED STRAW FILTER BARRIER (E-2)	
7-20-95	REVISED SILT FENCE E-4 AND E-11	7-20-95
7-15-94	REV. E-4 & E-11 MIN. 13" BURIED END OF FABRIC	
6-2-94	REVISED E-1, 4, 7 & 11; DELETED E-2 & 3	6-2-94
4-1-93	REDRAWN	
10-1-92	REDRAWN	
8-2-76	ISSUED R.D.M.	298-7-28-76
DATE	REVISION	FILMED

ARKANSAS STATE HIGHWAY COMMISSION

TEMPORARY EROSION CONTROL DEVICES

STANDARD DRAWING TEC-1

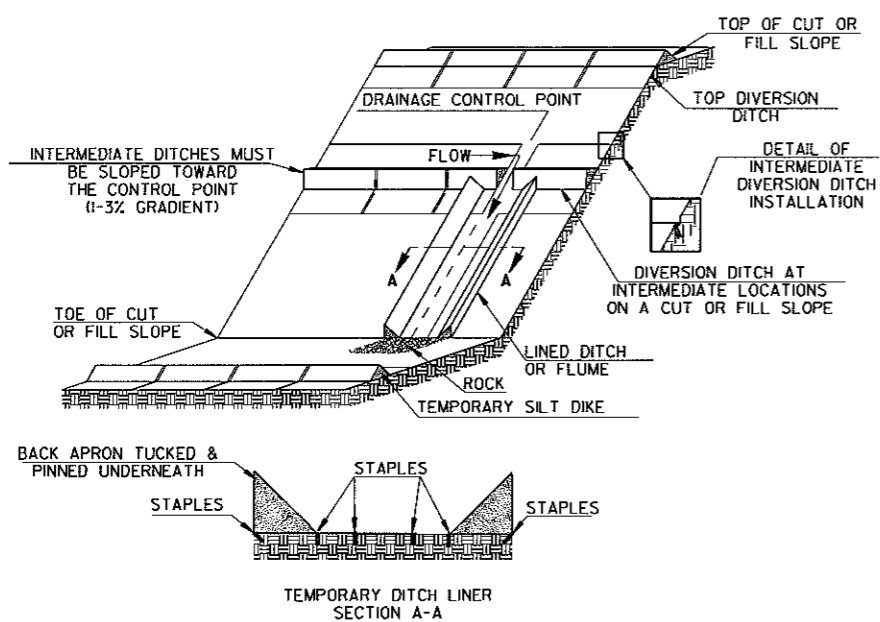

TRIANGULAR SILT DIKE INSTALLATION FOR DIVERSION DITCH AND/OR DITCH LINER

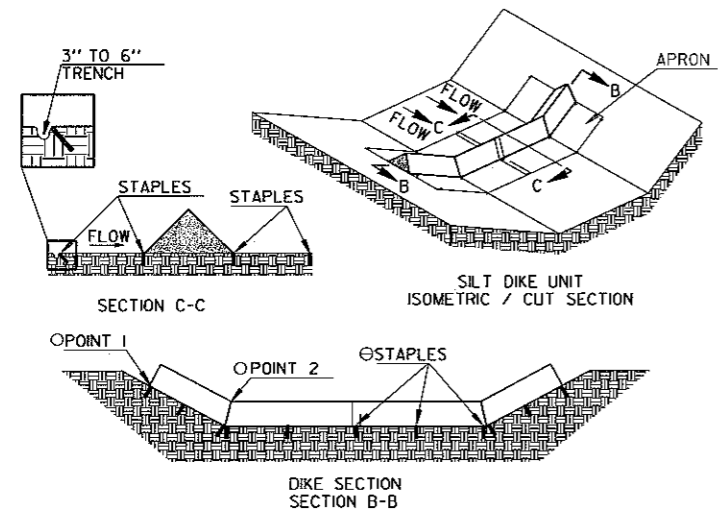

TRIANGULAR SILT DIKE INSTALLATION FOR ROADWAY DITCH OR DRAINAGE DITCH

○ POINT "1" MUST BE HIGHER THAN POINT "2" TO ENSURE THAT WATER FLOWS OVER THE DIKE AND NOT AROUND THE ENDS.  
 ⊗ STAPLES SHALL BE PLACED WHERE THE UNITS OVERLAP AND IN THE CENTER OF THE UNIT AS SHOWN ON THE DIAGRAM.

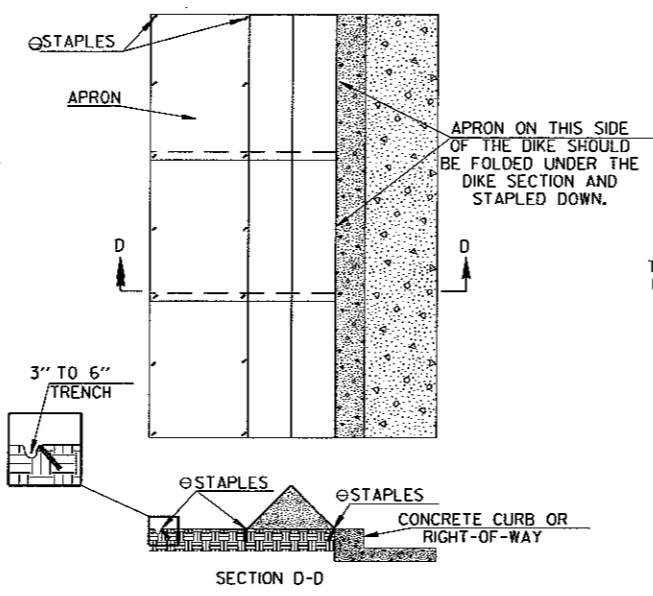

TRIANGULAR SILT DIKE INSTALLATION FOR CONTINUOUS BARRIER

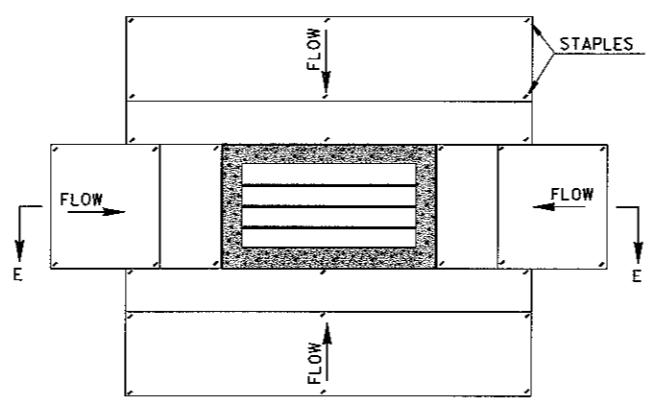

TRIANGULAR SILT DIKE INSTALLATION FOR DROP INLETS

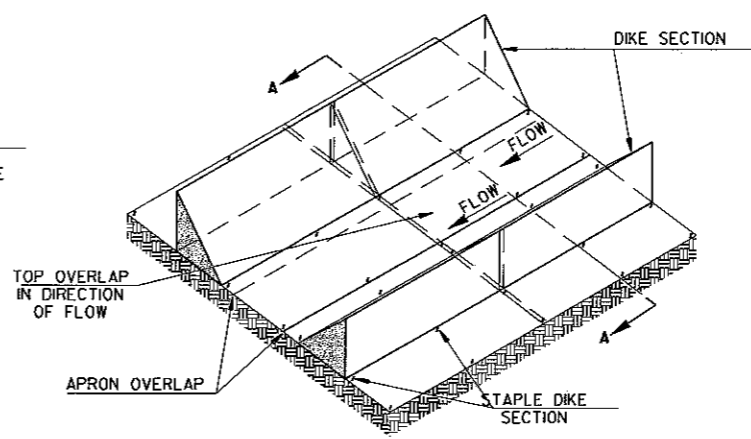

TRIANGULAR SILT DIKE INSTALLATION FOR TEMPORARY DITCH LINER

GENERAL NOTES

1. THIS WORK SHALL CONSIST OF FURNISHING, INSTALLING, AND MAINTAINING THE TRIANGULAR SILT DIKE. THE DIKES SHALL BE USED AS A CONTINUOUS LINE BARRIER AT THE TOE OF SLOPE OR ACROSS THE ROADWAY DITCH TO CONTAIN SEDIMENT AND MINIMIZE EROSION, OR AS DIRECTED BY THE ENGINEER. THESE DIKES SHALL BE INSTALLED AND LOCATED AS SOON AS CONSTRUCTION WILL ALLOW OR AS DIRECTED BY THE ENGINEER.
2. TRIANGULAR SILT DIKE SHALL BE TRIANGULAR SHAPED HAVING A HEIGHT OF AT LEAST 8" TO 10" IN THE CENTER WITH EQUAL SIDES AND A 16" TO 20" BASE. THE TRIANGULAR SHAPED INNER MATERIAL SHALL BE URETHANE FOAM. THE OUTER COVER SHALL BE A WOVEN GEOTEXTILE FABRIC PLACED AROUND THE INNER MATERIAL & ALLOWED TO EXTEND BEYOND BOTH SIDES OF THE TRIANGLE 24" TO 36". THIS FABRIC SHOULD BE MILDEW RESISTANT, ROT-PROOF AND RESISTANT TO HEAT AND ULTRAVIOLET RADIATION MEETING REQUIREMENTS FOR SEDIMENT CONTROL IN AASHTO M288. THE DIKES SHALL BE ATTACHED TO THE GROUND WITH WIRE STAPLES. THE STAPLES SHALL BE NO. 11 GAUGE WIRE AND BE AT LEAST 6" TO 8" LONG. STAPLES SHALL BE PLACED AS SHOWN ON THESE DETAILS.
3. ACCEPTED TRIANGULAR SILT DIKE, MEASURED AS PROVIDED ABOVE, WILL BE PAID FOR AT THE CONTRACT UNIT PRICE BID FOR TRIANGULAR SILT DIKE. PRICE BID WILL INCLUDE THE COST OF FURNISHING THE DIKES, INSTALLING, MAINTAINING AND REMOVAL WHEN DIRECTED BY THE ENGINEER.

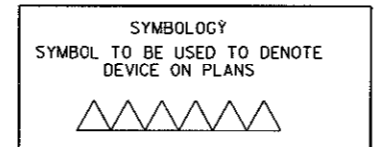

NOTE: SILT DIKE SHOULD ONLY BE USED FOR DROP INLETS IN SUMP LOCATIONS.

			ARKANSAS STATE HIGHWAY COMMISSION
			TEMPORARY EROSION CONTROL DEVICES
7-26-12	REVISED GENERAL NOTE 2.		STANDARD DRAWING TEC-4
12-15-11	ISSUED		
DATE	REVISION	FILMED	

**AUTHORIZATION TO DISCHARGE STORMWATER UNDER  
THE NATIONAL POLLUTANT DISCHARGE ELIMINATION SYSTEM AND THE  
ARKANSAS WATER AND AIR POLLUTION CONTROL ACT**

In accordance with the provisions of the Arkansas Water and Air Pollution Control Act (Ark. Code Ann. 8-4-101 et seq.), and the Clean Water Act (33 U.S.C. 1251 et seq.), an

**Operator of Facilities with Stormwater Discharges Associated with Construction Activity**

is authorized to discharge to all receiving waters except as stated in Part I.B.11 (Exclusions).

For large construction sites that are eligible for coverage under this General Permit (GP), the Arkansas Department of Energy and Environment - Division of Environmental Quality (DEQ), Office of Water Quality will provide a Notice of Coverage (NOC) with tracking permit number which starts with ARR15 and a copy of the permit to the facility. The cover letter includes the DEQ's determination that a facility is covered under the GP and may specify alternate requirements outlined in the permit.

Small construction sites that are eligible for coverage under this GP will be considered to have automatic coverage under this GP and must follow the permit requirements outlined in Condition 6 of Part I.

Effective Date: November 1, 2021

Expiration Date: October 31, 2026



Digitally signed by Alan J. York  
DN: cn=Alan J. York, o, ou,  
email=alan.york@adeq.state.ar.us,  
c=US  
Date: 2021.05.04 09:13:53 -05'00'

Alan J. York  
Associate Director, Office of Water Quality  
Division of Environmental Quality

05/04/2021

Issue Date

## **PART I PERMIT REQUIREMENTS**

Information in **Part I** is organized as follows:

**Section A:** Definitions with Included Commentary

**Section B:** Coverage Under this Permit:

1. Permitted Area
2. Eligibility
3. Responsibilities of the Operator
4. Where to Submit
5. Requirements for Qualifying Local Program (QLP)
6. Requirements for Coverage
7. Notice of Intent (NOI) Requirements
8. Posting Notice of Coverage (NOC)
9. Applicable Federal, State or Local Requirements
10. Allowable Non-Stormwater Discharges
11. Limitations on Coverage (Exclusions)
12. Short Term Activity Authorization (STAA)
13. Effluent Limitation Guidelines (ELG)
14. Natural Buffer Zones
15. Waivers from Permit Coverage
16. Notice of Termination (NOT)
17. Responsibilities of the Operator of a Larger Common Plan of Development for a Subdivision
18. Change in Operator
19. Late Notifications
20. Failure to Notify
21. Maintenance
22. Releases in Excess of Reportable Quantities
23. Attainment of Water Quality Standards
24. Requiring an Individual Permit



## SECTION A: DEFINITIONS WITH INCLUDED COMMENTARY

1. "**Arkansas Pollution Control and Ecology Commission**" shall be referred to as APC&EC throughout this permit.
2. "**Automatic Coverage**" is a term used to define the method of coverage for a small construction site.
3. "**Best Management Practices (BMPs)**" schedules of activities, prohibitions of practices, maintenance procedures, and other management practices to prevent or reduce the discharge of pollutants to waters of the State. BMPs also include treatment requirements, operating procedures, and practices to control construction site runoff, spillage or leaks, sludge or waste disposal, or drainage from raw material storage. According to the EPA BMP manual, the use of hay-bales in concentrated flow areas is not recommended as a BMP.
4. "**Cognizant Official**" is a duly authorized representative, as defined in Part II.B.9.B.
5. "**Commencement of Construction**" is the initial disturbance of soils (or breaking ground) associated with clearing, grading, or excavating activities or other construction-related activities (e.g., stockpiling of fill material; placement of raw materials at the site).
6. "**Contaminated**" is a substance the entry of which into the MS4, waters of the State, or Waters of the United States may cause or contribute to a violation of Arkansas water quality standards.
7. "**Control Measure**" as used in this permit, refers to any Best Management Practice or other method used to prevent or reduce the discharge of pollutants to waters of the State.
8. "**Construction Activity**" earth-disturbing activities, such as the clearing, grading, and excavation of land, and other construction-related activities (e.g., stockpiling of fill material; placement of raw materials at the site) that could lead to the generation of pollutants.
9. "**Construction Site**" is an area upon which one or more land disturbing construction activities occur that in total will disturb one acre or more of land, including areas that are part of a larger common plan of development or sale that may be less than one acre where multiple separate and distinct land disturbing construction activities may be taking place at different times on different schedules but under one plan such that the total disturbed area is one acre or more.
10. "**Construction Support Activity**" a construction-related activity that specifically supports the construction activity and involves earth disturbance of pollutant-generating activities of its own, and can include, but not limited to, activities associated with concrete or asphalt batch plants, equipment staging yards, materials storage areas, excavated material disposal areas, and burrow areas.
11. "**CWA**" is the Clean Water Act or the Federal Water Pollution Control Act.
12. "**Department**" is referencing the Department of Energy and Environment.
13. "**DEQ**" or "**Division**" is referencing the Division of Environmental Quality. The Division is the governing authority for the National Pollutant Discharge Elimination System program in the state of Arkansas.

14. "**Detention Basin**" is an area where excess stormwater is stored or held temporarily and then slowly drains when water levels in the receiving channel recede. In essence, the water in a detention basin is temporarily detained until additional room becomes available in the receiving channel.

15. "**Director**" is the Director of the Division of Environmental Quality, or a designated representative.

16. "**Discharge**" is when used without qualification means the "discharge of a pollutant".

17. "**Disturbed area**" is the total area of the site where any construction activity is expected to disturb the ground surface. This includes any activity that could increase the rate of erosion, including, but not limited to, clearing, grubbing, grading, excavation, demolition activities, haul roads, and areas used for staging. Also included are stockpiles of topsoil, fill material and any other stockpiles with a potential to create additional runoff.

18. "**Drainageway**" is an open linear depression, whether constructed or natural, that functions for the collection and drainage of surface water.

19. "**Duly Authorized Representative**" is a representative of the Responsible Official meeting the requirements specified in Part II.B.9.B.

20. "**Eligible**" refers to being qualified for authorization to discharge stormwater under this general permit.

21. "**Erosion**" is the process by which the land's surface is worn away by the action of wind, water, ice or gravity.

22. "**ERW**" Extraordinary Resource Water, in accordance with Rule 2.

23. "**ESW**" Ecologically Sensitive Waterbodies, in accordance with Rule 2.

24. "**Facility**" or "**Activity**" is any NPDES "point source" or any other facility or activity (including land or appurtenances thereto) that is subject to regulation under the NPDES program.

25. "**Final Stabilization**":

A. All soil disturbing activities at the site have been completed and either of the two following criteria are met:

- 1) A uniform (e.g., evenly distributed, without large bare areas) perennial vegetative cover with a density of 80% or more of the native background vegetative cover for the area has been established on all unpaved areas and areas not covered by permanent structures, or
- 2) Equivalent permanent stabilization measures (such as the use of riprap, gabions, or geotextiles) have been employed.

B. When background native vegetation will cover less than 100% of the ground (e.g., arid areas, beaches), the 80% coverage criteria is adjusted as follows: if the native vegetation covers 50% of the ground, 80% of 50% ( $0.80 \times 0.50 = 0.40$ ) would require 40% total cover for final stabilization. On a beach with no natural vegetation, no stabilization is required.

C. For individual lots in residential construction, final stabilization means that either:

- 1) The homebuilder has completed final stabilization as specified above, or

- 2) The homebuilder has established temporary stabilization including perimeter controls for an individual lot prior to occupation of the home by the homeowner and informing the homeowner of the need for, and benefits of, final stabilization.

D. For construction projects on land used for agricultural purposes (e.g., pipelines across crop or range land, staging areas for highway construction, etc.), final stabilization may be accomplished by returning the disturbed land to its pre-construction agricultural use. Areas disturbed that were not previously used for agricultural activities, such as buffer strips immediately adjacent to “waters of the State”, and areas which are not being returned to their pre-construction agricultural use shall meet the final stabilization criteria in A, B, or C above.

26. "**Grading Activities**" as used in this permit are those actions that disturb the surface layer of the ground to change the contouring, surface drainage pattern, or any other slope characteristics of the land without significantly adding or removing on-site rock, soil, and other materials. This can include demolition, excavation, and filling.

27. "**Impaired Water**" is a waterbody listed in the current, approved Arkansas 303(d) list.

28. "**Infrastructure**" refers to streets, drainage, curbs, utilities, etc.

29. "**Landscaping**" is improving the natural beauty of a piece of land (i.e. entrance of subdivision) through plantings or altering the contours of the ground.

30. "**Large Construction Site**" is a construction site in which construction activity including clearing, grading and excavation. Construction activity also includes the disturbance of less than five acres of total land area that is a part of a larger common plan of development or sale if the larger common plan will ultimately disturb five acres or greater. (Please see Part I.B.15 for partial waivers.)

31. "**Larger Common Plan of Development or Sale**" is a contiguous (sharing a boundary or edge; adjacent; touching) area where multiple and distinct construction activities may be taking place at different times on different schedules under one plan. Such a plan might consist of many small projects (e.g. a common plan of development for a residential subdivision might lay out the streets, house lots, and areas for parks, schools and commercial development that the developer plans to build or sell to others for development). All these areas would remain part of the common plan of development or sale. The following items can be used as guidance for deciding what might or might not be considered a “Common Plan of Development or Sale.” The “plan” in a common plan of development or sale is broadly defined as any announcement or piece of documentation (including a sign, public notice or hearing, sales pitch, advertisement, drawing, permit application, zoning request, computer design, etc.) or physical demarcation (including boundary signs, lot stakes, surveyor markings, etc.) indicating construction activities may occur on a specific plot. The applicant shall still meet the definition of operator in order to be required to get permit coverage, regardless of the acreage that is personally disturbed.

If a smaller project (i.e., less than 1 acre) is part of a larger common plan of development or sale (e.g., you are building a residential home on a ½ acre lot in a 40 acre subdivision or are putting in a fast food restaurant on a ¾ acre pad that is part of a 20 acre retail center), permit coverage is required.

32. "**Losing Stream Segment**" a stream segment which, beginning at the point of existing or proposed discharge and extending two (2) miles downstream, contribute thirty percent (30%) or more of its flow at a 7Q10 flow or one (1) cfs, whichever is greater, through natural processes such as permeable subsoil or cavernous bedrock into an aquifer.

33. "**Natural Buffer**" for purposes of this permit, an area of undisturbed natural cover surrounding waters of the State. Natural cover includes vegetation, exposed rock, or barren ground that exists prior to commencement of construction activities

at the site.

- 34. "NOC" Notice of Coverage.
- 35. "NOI" Notice of Intent to be covered by this permit.
- 36. "NOT" Notice of Termination.
- 37. "NSW" Natural and Scenic Waterways, in accordance with Rule 2.

38. "Operator"/"Permittee" for the purpose of this permit and in the context of stormwater associated with construction activity, means any person(s), an individual, association, partnership, corporation, municipality, state or federal agency, associated with a construction project that has financial and operational control over construction plans and specifications, including the ability to make modifications to those plans and specifications; additionally, the Division may require any person(s), an individual, association, partnership, corporation, municipality, state or federal agency, associated with a construction project that has day-to-day operational control of those activities at a project that are necessary to ensure compliance with the permit conditions can be named as a co-permittee.

In addition, for purposes of this permit and determining who is an operator, "owner" refers to the party that owns the structure being built. Ownership of the land where construction is occurring does not necessarily imply the property owner is an operator (e.g., a landowner whose property is being disturbed by construction of a gas pipeline or a landowner who allows a mining company to remove dirt, shale, clay, sand, gravel, etc. from a portion of his property). Likewise, if the erection of a structure has been contracted for, but possession of the title or lease to the land or structure is not to occur until after construction, the would-be owner may not be considered an operator (e.g., having a house built by a residential homebuilder).

- 39. "Outfall" a point source where stormwater leaves the construction site.
- 40. "Owner" refers to the owner or operator of any "facility or activity" subject to regulation under the NPDES program. In addition, for purposes of this permit and determining who is an operator, "owner" refers to the party that owns the structure being built. Ownership of the land where construction is occurring does not necessarily imply the property owner is an operator (e.g., a landowner whose property is being disturbed by construction of a gas pipeline). Likewise, if the erection of a structure has been contracted for, but possession of the title or lease to the land or structure is not to occur until after construction, the would-be owner may not be considered an operator (e.g. having a house built by a residential homebuilder).
- 41. "Physically Interconnected" means that one municipal separate storm sewer system is connected to a second municipal separate storm sewer system in such a way that it allows for direct discharges into the second system.
- 42. "Point Source" is any discernible, confined, and discrete conveyance, including but not limited to, any pipe, ditch, channel, tunnel, conduit, well, discrete fissure, container, rolling stock, concentrated animal feeding operation, landfill leachate collection system, vessel or other floating craft from which pollutants are or may be discharged. This term does not include return flows from irrigated agriculture or agricultural stormwater runoff.
- 43. "Qualified Local Program" is a municipal program for stormwater discharges associated with construction sites that has been formally approved by DEQ.
- 44. "Qualified personnel" a person knowledgeable in the principles and practice of erosion and sediment controls who possesses the skills to assess conditions at the construction site that could impact stormwater quality and to assess the effectiveness of any sediment and erosion control measures selected to control the quality of stormwater discharges from the

construction activity.

45. "**Regulated Small Municipal Separate Storm Sewer System**" are all municipal separate storm sewer systems that are either:

- A. Located within the boundaries of an "urbanized area" with a population of 50,000 or more as determined by the latest Decennial Census by the Bureau of Census; or
- B. Owned or operated by a municipality other than those described in paragraph A and that serve a jurisdiction with a population of at least 10,000 and a population density of at least 1,000 people per square mile; or
- C. Owned or operated by a municipality other than those described in paragraphs A and B and that contributes substantially to the pollutant loadings of a "physically interconnected" municipal separate storm sewer system.

46. "**Responsible Official**" is the authorized representative, as defined in Part II.B.9.A.

47. "**Retention Basin**" a basin that is designed to hold the stormwater from a rain event and allow the water to infiltrate through the bottom of the basin. A retention basin also stores stormwater, but the storage of the stormwater would be on a more permanent basis. In fact, water often remains in a retention basin indefinitely, with the exception of the volume lost to evaporation and the volume absorbed into the soils. This differs greatly from a detention basin, which typically drains after the peak of the storm flow has passed, sometimes while it is still raining.

48. "**Runoff Coefficient**" is the fraction of total rainfall that will appear at the conveyance as runoff.

49. "**Sediment**" is material that settles to the bottom of a liquid.

50. "**Sediment Basin**" is a basin that is designed to maintain a 10 year-24 hour storm event for a minimum of 24-hours in order to allow sediment to settle out of the water.

51. "**Small Construction Site**" is a construction site in which construction activities including clearing, grading, and excavating that result in land disturbance of equal to or greater than one acre and less than five acres. Small construction activity also includes the disturbance of less than one acre of total land area that is part of a larger common plan of development or sale if the larger common plan will ultimately disturb equal to or greater than one and less than five acres. Small construction activity does not include routine maintenance that is performed to maintain the original line and grade, hydraulic capacity, or original purpose of the facility.

52. "**Stormwater**" is stormwater runoff from rainfall, snow melt runoff, and surface runoff and drainage.

53. "**Stormwater Discharge Associated with Construction Activity**" refers to the discharge of runoff from any conveyance which is used for collecting and conveying stormwater and which is directly related to construction activity.

54. "**Stormwater Pollution Prevention Plan (SWPPP or SWP3)**" is a plan that includes site map(s), an identification of construction/contractor, activities that could cause pollutants in the stormwater, and a description of measures or practices to control these pollutants.

55. "**Temporary Sediment Controls**" are controls that are installed to control sediment runoff from the site during construction activity. These could be silt fencing, rock check dams, etc.

56. "**Total Maximum Daily Load**" or "**TMDL**" is the sum of the individual wasteload allocations (WLAs) for point sources and load allocations (LAs) for non-point sources and natural background. If the receiving water has only one point

source discharger, the TMDL is the sum of that point source WLA plus the LAs for any non-point sources of pollution and natural background sources, tributaries, or adjacent segments. TMDLs can be expressed in terms of mass per time, toxicity, or other appropriate measure.

**57. "Uncontaminated"** means that the water will not exceed the water quality standards as set forth in APC&EC Rule 2; also not containing a harmful quantity of any substance.

**58. "Urbanized Area"** means the areas of urban population density delineated by the Bureau of the Census for statistical purposes and generally consisting of the land area comprising one or more central place(s) and the adjacent densely settled surrounding area that together have a residential population of at least 50,000 and an overall population density of at least 1,000 people per square mile as determined by the latest Decennial Census by the Bureau of Census.

**59. "Waters of the State"** waters of the State means all streams, lakes, marshes, ponds, watercourses, waterways, wells, springs, irrigation systems, drainage systems, and all other bodies or accumulations of water, surface and underground, natural or artificial, public or private, which are contained within, flow through, or border upon this state or any portion of the state.

## SECTION B: COVERAGE UNDER THIS PERMIT

### Introduction

This Construction General Permit (CGP) authorizes stormwater discharges from large and small construction activities that result in a total land disturbance of equal to or greater than one acre or less than one acre of total land area that is part of a larger common plan of development or sale if the larger common plan will ultimately disturb equal to or greater than one acre. This permit also authorizes stormwater discharges from any other construction activity designated by DEQ where DEQ makes that designation based on the potential for contribution to an excursion of a water quality standard or for significant contribution of pollutants to waters of the State. This permit replaces the permit issued in 2016. The goal of this permit is to minimize the discharge of stormwater pollutants from construction activity into waters of the State. The operator shall read and understand the conditions of the permit. A copy of the CGP is available on the DEQ web site at <https://www.adeg.state.ar.us/water/permits/npdes/stormwater/>. A hard copy may be obtained by contacting the DEQ's General Permits Section at (501) 682-0623.

1. **Permitted Area.** If a large or small construction activity is located within the State of Arkansas, the operator may be eligible to obtain coverage under this permit.
2. **Eligibility.** Permit eligibility is limited to discharges from “large” and “small” construction activity, or as otherwise designated by DEQ. This general permit contains eligibility restrictions, as well as permit conditions and requirements. Operators shall meet the requirements of Part I.B.6.A or Part I.B.6.B to be eligible for coverage under this permit. In such cases, operators shall continue to satisfy those eligibility provisions to maintain permit authorization. If operators do not meet the requirements that are a pre-condition to eligibility, then resulting discharges constitute unpermitted discharges. By contrast, if operators are eligible for coverage under this permit and do not comply with the requirements of the general permit, they may be in violation of the general permit for otherwise eligible discharges.
  - A. This general permit authorizes discharges from construction activities as defined in 40 C.F.R. §122.26(a), 40 C.F.R. §122.26(b)(14)(x), 40 C.F.R. §122.26(b)(15)(i)-(ii) and 40 C.F.R. §450.
  - B. This permit also authorizes stormwater discharges from support activities (e.g., concrete or asphalt batch plants, concrete truck washout, fueling, equipment staging yards, materials storage areas, excavated material disposal areas, stockpiles of top soil, borrow areas) provided:
    - 1) The support activity is directly related to a specific construction site that is required to have NPDES permit coverage for discharges of stormwater associated with the construction activity;
    - 2) The support activity is not a commercial operation, nor does it serve multiple unrelated construction projects; and does not continue to operate beyond the completion of the construction activity at the project it supports;
    - 3) Pollutant discharges from support activity areas are minimized in compliance with conditions of this permit; and
    - 4) Discharges from the support activity areas shall be identified in a Stormwater Pollution Prevention Plan (SWPPP) stating appropriate controls and measures for the areas off the construction site.
  - C. Other activities may be considered for this permit at the discretion of the Director as defined in 40 C.F.R. §122.26(b)(15)(ii).

3. **Responsibilities of the Operator.** Permittees with operational control are responsible for compliance with all applicable terms and conditions of this permit as it relates to their activities on the construction site including construction support activities off site, including protection of endangered species and implementation of BMPs and other controls required by the SWPPP. Receipt of this general permit does not relieve any operator of the responsibility to comply with any other applicable federal, state or local statute, ordinance or regulation.
4. **Where to Submit.** The operator shall submit a complete and signed Notice of Intent (NOI) and SWPPP to DEQ through ePortal, unless the operator receives a waiver from DEQ, which can be found on the following website:

<https://eportal.adeq.state.ar.us/>

- A. The operator shall submit the application fee to DEQ through ePortal (when available), submit an email requesting an invoice to be created to pay online, or mail in invoice from ePortal with a check (listing the invoice number on the check) to the follow address:

Division of Environmental Quality  
ATTN: Fiscal  
5301 Northshore Drive  
North Little Rock, AR 72118-5317

NOTE: Notice of Coverage (NOC) will **NOT** be issued until payment has been received by DEQ.

- B. Waivers from electronic reporting may be granted based on one of the following conditions:

- 1) If the operational headquarters is physically located in a geographic area (i.e. Zip code or census tract) that is identified as under-served for broadcast internet access in the most recent report from the Federal Communications Commission;
- 2) If available computer access or computer capability is limited; or
- 3) If the operator is a religious community that choose not to use certain modern technologies pursuant to 40 C.F.R. §127.15(c)(1).

- C. In order to apply for a waiver from the electronic reporting, the operator must submit the required information outlined in 40 C.F.R. §127.15(b)(2).

- D. If DEQ grants a waiver approval to use a paper NOI, and operator elects to use it, the operator **must** use the approved form developed by DEQ.

5. **Requirements for Qualifying Local Program (QLP).** DEQ reviews and approves the QLPs to ensure that they meet or supersede both state and federal requirements outlined in this permit and 40 C.F.R. §122.44(s). DEQ will review the QLP at least every 5 years for recertification. If DEQ approves a QLP, then the QLP requirements shall at the minimum meet the DEQ's requirements. This includes all templates and forms. This permit may be modified to add new QLPs or modify existing QLPs at DEQ's discretion. All public notice and other applicable costs incurred by the modification of the permit for the addition or modification of a QLP will be paid by the QLP.

If a small construction site is within the jurisdiction of a QLP, the operator of the small construction site is authorized to discharge stormwater associated with construction activity under QLP permit requirements only.

At the time of issuance of this permit, only the City of Hot Springs is meeting the DEQ minimum requirements.



## 6. Requirements for Coverage.

A. Small Construction Sites. An operator of a small construction site will be considered to have automatic coverage under this general permit and may discharge without submitting a NOI, SWPPP or fee if the following conditions are met:

- 1) A completed Notice of Coverage (NOC) must be posted at the site prior to commencing construction and remain posted until final stabilization is completed;
- 2) A Stormwater Pollution Prevention Plan must be prepared in accordance with good engineering practice as described in Rule 6.203(B), completed prior to posting the NOC, implemented upon commencement of construction activities, and the latest copy must be maintained at the construction site;
- 3) All permit conditions set forth in this general permit must be followed; and
- 4) The operator is responsible for ensuring that the site is in compliance with any changes or updates of this general permit, by either contacting DEQ or reviewing the DEQ website:

<https://www.adeg.state.ar.us/water/permits/npdes/stormwater/>

B. Large Construction Sites. An operator of a large construction site discharging under this general permit shall submit the following items at least ten (10) business days prior to the commencement of construction activities:

- 1) A complete NOI in accordance with the requirements of Part I.B.7 of this permit.
- 2) A complete SWPPP in accordance with the requirements of Part II.A of this permit.
- 3) An initial permit fee shall accompany the NOI under the provisions of APC&EC Rule 9. Subsequent annual fees will be billed by DEQ until the operator has requested a termination of coverage by submitting a Notice of Termination (NOT). Failure to remit the required initial permit fee shall be grounds for the Director to deny coverage under this general permit. Failure to remit the required annual fees shall be grounds for the Director to revoke coverage under this permit.

C. Modification of Permit Coverage to Include Additional Acreage. Any request to increase the total acreage of a construction site shall be accompanied by a \$200 permit modification fee and an updated SWPPP. Any request to only increase the disturbed acreage without changing the total acreage shall be accompanied by an updated SWPPP. A \$200 permit modification fee is not required with an increase in disturbed acreage. The operator shall submit a complete and signed Additional Acreage Request Form to DEQ through ePortal, which can be found on the following website:

<https://eportal.adeg.state.ar.us/>

## 7. Notice of Intent (NOI) Requirements.

A. NOI Form. Large construction site operators who intend to seek coverage for a stormwater discharge under this general permit shall submit a complete and accurate DEQ NOI form through the ePortal system (at <https://eportal.adeg.state.ar.us/>) at least ten (10) business days prior to the date coverage under this permit is desired, unless granted a waiver in accordance with Part I.B.4.D. The NOI form completed **must** be the current version obtained from ePortal.

If the NOI is deemed incomplete, DEQ will notify the applicant with regard to the deficiencies by a letter, email, or phone within ten (10) business days of the receipt of the NOI. If the operator does not receive a notification of deficiencies from DEQ's receipt of the NOI, the NOI is deemed complete. If the applicant does not provide DEQ with the requested deficiencies within the deadline set by DEQ, then DEQ will return the NOI, fee and SWPPP back to the

applicant.

B. Contents of the NOI. The NOI form contains, at a minimum, the following information:

- 1) Operator (Permittee) information (name, mailing address, telephone, and E-mail address)
- 2) Whether the operator is a federal, state, private, public, corporation, or other entity
- 3) Invoice mailing information (name, address, and telephone and fax numbers)
- 4) Project Construction site information (name, county, address, contact person, directions to the site, latitude and longitude for the entrance of the site or the endpoints for linear project (in degrees, minutes, and seconds), estimated construction start date and completion date through site final stabilization, the total project acreage and the acreage to be disturbed by the operator submitting the NOI, type of the project (subdivision, school, etc), whether the project is part of a larger common plan of development or sale.)
- 5) Discharge information (name of the receiving stream, ultimate receiving stream, name of municipal storm sewer system)
- 6) List of current permits
- 7) The Certification statement and signature of a qualified signatory person in accordance with 40 CFR 122.22, as adopted by reference in APC&EC Rule 6
- 8) The certification of the facility corporation
- 9) Other information (location of the SWPPP)
- 10) And the SIC Code.

C. Notice of Coverage (NOC). Unless notified by the Director to the contrary, operators who submit a complete NOI and SWPPP in accordance with the requirements of this permit are authorized to discharge stormwater from the construction sites under the terms and conditions of this permit ten (10) business days after the date the NOI is deemed complete (which may not be the original submission date if revisions or additions were necessary) by DEQ. If the NOC has not been received by the permittee ten (10) business days after the date the NOI is deemed complete by DEQ, the NOI may be posted until the NOC is received. Upon review of the NOI and other available information, the Director may deny coverage under this permit and require submittal of an application for an individual NPDES permit.

## 8. Posting Notice of Coverage (NOC).

A. Automatic Coverage Sites. The NOC for small sites, as defined in Part I.A.51, shall be obtained from the DEQ's Stormwater website:

<https://www.adeg.state.ar.us/water/permits/npdes/stormwater/> .

The NOC must be posted at the site prior to commencing construction. In addition, a copy of the latest signed and certified SWPPP must be available at the construction site in accordance with Part II.A.2.B and D prior to commencing construction.

B. Large Sites: NOC Posting for Large Construction Sites. The posting for large construction sites shall be obtained from DEQ only after the permittee has submitted the required NOI, permit fee and complete SWPPP to DEQ for the coverage.

C. Linear Projects. If the construction project is a linear construction project (e.g., pipeline, highway, etc.), the notice shall be placed in a publicly accessible location near where construction is actively underway and moved as necessary.

Please note, this permit does not provide the public with any right to trespass on a construction site for any reason, including inspection of a site; nor does this permit require that the permittee allow members of the public access to a construction site.

9. **Applicable Federal, State or Local Requirements.** The operator shall ensure that the stormwater controls implemented at the site are consistent with all applicable federal, state, or local requirements. Additionally, an operator who is operating under approved local erosion and sediment plans, grading plans, local stormwater permits, or stormwater management plans shall submit signed copies of the NOI to the local agency (or authority) upon the local agency's request.

10. **Allowable Non-Stormwater Discharges.**

- A. The following non-stormwater discharges as part of the construction activity may be authorized by this permit through appropriate controls. Non-stormwater discharges shall be addressed in the stormwater pollution prevention plan and measures to minimize or eliminate non-stormwater discharge should be taken if reasonably possible.
- 1) Fire-fighting activities;
  - 2) Fire hydrant flushings;
  - 3) Water used to wash vehicles and equipment (where detergents, soaps, solvents or other chemicals are not used) or to control dust in accordance with Part II.A.4.J.2;
  - 4) Potable water sources including uncontaminated waterline flushings;
  - 5) Uncontaminated landscape irrigation;
  - 6) Uncontaminated routine external building wash down which does not use detergents, soaps, solvents or other chemicals;
  - 7) Uncontaminated pavement wash waters where spills or leaks of toxic or hazardous materials have not occurred (unless all spilled materials have been removed) and where detergents, soaps, solvents or other chemicals are not used);
  - 8) Uncontaminated air conditioning compressor condensate (See Part I.B.13.C of this permit);
  - 9) Uncontaminated springs, excavation dewatering and uncontaminated groundwater (See Part I.B.13.C of this permit);
  - 10) Foundation or footing drains where flows are not contaminated with process materials such as solvents or contaminated groundwater (See Part I.B.13.C of this permit).

11. **Limitations on Coverage (Exclusions).** The following stormwater discharges associated with construction activity are not covered by this permit:

- A. **Post Construction Discharge.** Stormwater discharges associated with construction activities that originate from the site, as well as construction support activities located off site, after construction activities have been completed, the site has undergone final stabilization, and the permit has been terminated.
- B. **Discharges Mixed with Non-Stormwater.** Stormwater discharges that are mixed with sources of non-stormwater other than those identified in Part I.B.10.
- C. **Discharges Covered by another Permit.** Stormwater discharges associated with construction activity that are covered under an individual or an alternative general permit may be authorized by this permit after an existing permit expires, provided the expired permit did not establish numeric effluent limitations for such discharges.
- D. **Discharges into Receiving Waters with an Approved TMDL.** Discharges from a site into receiving waters for which there is an established total maximum daily load (TMDL) allocation (<https://www.adeg.state.ar.us/water/planning/integrated/tmdl/>) are not eligible for coverage under this permit unless the permittee develops and certifies a SWPPP that is consistent with the assumptions and requirements in the EPA approved TMDL. To be eligible for coverage under this general permit, operators shall incorporate into their SWPPP all conditions applicable to their discharges necessary for consistency with the assumptions and requirements of the TMDL within the timeframes established in the TMDL. If a specific numeric allocation has been established that

applies to the project's discharges, the operator shall incorporate that allocation into its SWPPP and implement necessary steps to meet that allocation. If a numeric limit has been assigned to the facility, quarterly monitoring shall be submitted to DEQ demonstrating compliance with the assigned Waste Load Allocation established in the TMDL. Please note that DEQ will be reviewing this information. If it is determined that the project will discharge into a receiving stream with a TMDL, then DEQ may require additional BMPs.

- E. Discharges into Impaired Receiving Waters (303(d) List). If stormwater discharges from a construction site enters the receiving water listed as impaired under Section 303(d) of the Clean Water Act (<https://www.adeg.state.ar.us/water/planning/integrated/>), the permittee shall incorporate into the SWPPP the additional BMPs needed to sufficiently protect water quality. Please note that DEQ will be reviewing this information. If it is determined that the project will discharge to an impaired water body, then DEQ may require additional BMPs.
- F. Discharges into an Extraordinary Resource Water (ERW), Natural and Scenic Waterway (NSW), or Ecologically Sensitive Waterbody (ESW). Discharges from a construction site located within the watershed of any water body or waterway designated as an Outstanding Resource Water as defined in the APC&EC Rule 2.203, including ERWs, NSWs, or ESWs are not eligible for coverage under this permit unless the permittee develops and certifies a SWPPP that includes additional BMPs needed to prevent to the maximum extent possible exposure to precipitation and to stormwater of pollutants that could potentially impact water quality. For the purposes of this permit, the watershed of an Outstanding Resource Water will be identified by the United States Geological Survey's twelve (12) digit Hydrological Unit Code (HUC). Please note that DEQ will be reviewing this information. If the site will discharge to an ERW, NSW, or ESW, then DEQ may determine that additional requirements are necessary.
- G. Discharges into an area of the state which includes potential losing stream and/or sensitive aquatic species native to these areas. Discharges from a construction site located within the watershed of any potential losing stream and/or sensitive aquatic species native to the area are not eligible for coverage under this permit unless the permittee develops and certifies a SWPPP that includes additional BMPs needed to prevent to the maximum extent possible exposure to precipitation and to stormwater of pollutants that could potentially impact water quality. In accordance with Part I.B.3, it is the responsibility of the permittee to prevent activity which may take or otherwise risk harm to endangered species. Please note that DEQ will be reviewing this information. If the site will discharge to an area of the state which includes potential losing stream and/or sensitive aquatic species native to these areas, then DEQ may determine that additional requirements are necessary.

**12. Short Term Activity Authorization (STAA).** Any work being conducted in waters of the State will require a STAA from DEQ in accordance with Rule 2.305. An STAA is necessary for any in-stream activity that has the potential to exceed the water quality standards, including, but not limited to: gravel removal, bridge or crossing repair/maintenance, bank stabilization, debris removal, culvert replacement, flood control projects, and stream relocation. Any work being conducted in Waters of the United States may require a Section 404 permit from the U.S. Army Corps of Engineers. This permit does not authorize any activity under an STAA, Individual 401 Certification, or Section 404 permit. The necessary forms to apply for coverage under an STAA or Individual 401 Certification can be found on the following website:

<https://www.adeg.state.ar.us/water/planning/instream/>

The SWPPP shall be updated to include a copy of the STAA letter (and Individual 401 Certification if needed) upon receipt. Re-submittal of the SWPPP is not required unless specifically requested by DEQ.

**13. Effluent Limitation Guidelines (ELG).** All permittees shall comply with the following effluent limits:

- A. Erosion and Sediment Controls. Design, install, and maintain effective erosion controls and sediment controls to minimize the discharge of pollutants. At a minimum, such controls shall be designed, installed and maintained to:

- 1) Control stormwater volume and velocity to minimize soil erosion in order to minimize pollutant discharges;
  - 2) Control stormwater discharges, including both peak flowrates and total stormwater volume, to minimize channel and streambank erosion and scour in the immediate vicinity of discharge points;
  - 3) Minimize the amount of soil exposed during construction activity;
  - 4) Minimize the disturbance of steep slopes;
  - 5) Minimize sediment discharges from the site. The design, installation and maintenance of erosion and sediment controls shall address factors such as the amount, frequency, intensity and duration of precipitation, the nature of resulting stormwater runoff, and soil characteristics, including the range of soil particle sizes expected to be present on the site;
  - 6) Provide and maintain natural buffers around waters of the State, direct stormwater to vegetated areas and maximize stormwater infiltration to reduce pollutant discharges, unless infeasible;
  - 7) Minimize soil compaction. Minimizing soil compaction is not required where the intended function of a specific area of the site dictates that it be compacted; and
  - 8) Unless infeasible, preserve topsoil. Preserving topsoil is not required where the intended function of a specific area of the site dictates that the topsoil be disturbed or removed.
- B. *Soil Stabilization.* Stabilization of disturbed areas must, at a minimum, be initiated immediately (unless weather conditions do not allow immediate initiation) whenever any clearing, grading, excavating or other earth disturbing activities have permanently ceased on any portion of the site, or temporarily ceased on any portion of the site and will not resume for a period exceeding fourteen (14) calendar days. In arid, semiarid, and drought-stricken areas where initiating vegetative stabilization measures immediately is infeasible, alternative stabilization measures must be employed as specified by the permitting authority. Stabilization must be completed within fourteen (14) calendar days. In limited circumstances, stabilization may not be required if the intended function of a specific area of the site necessitates that it remain disturbed.
- C. *Dewatering.* Discharges from dewatering activities, including discharges from dewatering of trenches and excavations, are prohibited unless managed by appropriate controls. There shall be no turbid discharges to waters of the State resulting from dewatering activities. If trench or ground waters contain sediment, it shall pass through a sediment settling pond or other equally effective sediment control device, prior to being discharged from the construction site. Alternatively, sediment may be removed by settling in place or by dewatering into a sump pit, filter bag, or comparable practice. Ground water dewatering which does not contain sediment or other pollutants is not required to be treated prior to discharge. However, care shall be taken when discharging ground water to ensure that it does not become pollutant-laden by traversing over disturbed soils or other pollutant sources.
- D. *Pollution Prevention Measures.* Design, install, implement, and maintain effective pollution prevention measures to minimize the discharge of pollutants. At a minimum, such measures shall be designed, installed, implemented and maintained to:
- 1) Minimize the discharge of pollutants from equipment and vehicle washing, wheel wash water, and other wash waters. Wash waters shall be treated in a sediment basin or BMP control that provides equivalent or better treatment prior to discharge;
  - 2) Minimize the exposure of building materials, building products, construction wastes, trash, landscape materials, fertilizers, pesticides, herbicides, detergents, sanitary waste and other materials present on the site to precipitation and to stormwater. Minimization of exposure is not required in cases where the exposure to precipitation and to stormwater will not result in a discharge of pollutants, or where exposure of a specific material or product poses little risk of stormwater contamination (such as final products and materials intended for outdoor use); and
  - 3) Minimize the discharge of pollutants from spills and leaks and implement chemical spill and leak prevention and response procedures.

E. Prohibited discharges. The following discharges are prohibited:

- 1) Wastewater from washout of concrete, unless managed by an appropriate control;
- 2) Wastewater from washout and cleanout of stucco, paint, form release oils, curing compounds and other construction materials;
- 3) Fuels, oils, or other pollutants used in vehicle and equipment operation and maintenance; and
- 4) Soaps, solvents, or detergents used in vehicle, equipment washing, or external building washdown.
- 5) Toxic or hazardous substances from a spill or release.

F. Surface Outlets. When discharging from basins and impoundments, utilize outlet structures that withdraw water from the surface, unless infeasible.

**14. Natural Buffer Zones**. A natural buffer zone as stated below shall be maintained at all times and direct stormwater to vegetated areas and maximize stormwater infiltration to reduce pollutant discharges, unless infeasible. Exceptions from this requirement for areas such as water crossings, limited water access, and restoration of the buffer are allowed if the permittee fully documents in the SWPPP the circumstances and reasons for the buffer zone encroachment. Additionally, this requirement is not intended to interfere with any other ordinance, rule or regulation, statute or other provision of law.

- A. For construction projects where construction activities or construction support activities occur, the SWPPP shall provide at least twenty-five (25) feet of natural buffer zone, as measured horizontally from the top of the bank to the disturbed area, from any waters of the State.
- B. DEQ will require at least fifty (50) feet of natural buffer zone, as measured horizontally from the top of the bank to the disturbed area, from established TMDL water bodies, streams listed on the 303(d) list, an Extraordinary Resource Water (ERW), Ecologically Sensitive Waterbody (ESW), Natural and Scenic Waterway (NSW), or any other uses at the discretion of the Director.
- C. Linear projects will be evaluated individually by DEQ to determine natural buffer zone setbacks.

**15. Waivers from Permit Coverage**. The Director may waive the otherwise applicable requirements of this general permit for stormwater discharges from construction activities under the terms and conditions described in this section.

- A. Waiver Applicability and Coverage. Based upon 40 C.F.R. §122.26.b.15.i.A, operators of small construction activities may apply for and receive a waiver from the requirements to obtain this permit.
- B. No Stormwater Leaving the Site. If all of the stormwater from the construction activity is captured on-site under any size storm event and allowed to evaporate, soak into the ground on-site, or is used for irrigation, a permit is not needed.
- C. TMDL Waivers. This waiver is available for sites with automatic coverage if the DEQ has established or approved a TMDL that addresses the pollutant(s) of concern and has determined that controls on stormwater discharges from small construction activity are not needed to protect water quality. The pollutant(s) of concern include sediment (such as total suspended solids, turbidity or siltation) and any other pollutant that has been identified as a cause of impairment of any water body that will receive a discharge from the construction activity. The operator must certify to the Director that construction activity will take place, and storm water discharges will occur within the drainage area addressed by the TMDL or equivalent analysis. Information on approved TMDLs is available on DEQ's website:

<https://www.adeg.state.ar.us/water/planning/integrated/tmdl/>.

**16. Notice of Termination (NOT).** When all construction activities that disturbed soil are complete, the site has reached final stabilization (100% stabilization with 80% density or greater, or as defined in Part I.A.25.B for sites where background native vegetation will cover less than 100% of the ground), all stormwater discharges from construction activities authorized by this permit are eliminated and all temporary sediment controls are removed and properly disposed, the operator of the facility may submit a complete Notice of Termination (NOT) to the Director. Along with the NOT, pictures that represent the entire site shall be submitted for review. Final stabilization is not required if the land is returned to its pre-construction agriculture use. Operators of small construction sites are not required to submit NOTs for their construction sites. However, final stabilization is required on all sites. If a NOT is not submitted when the project is completed, the operator will be responsible for annual fees.

**17. Responsibilities of the Operator of a Larger Common Plan of Development or Sale.**

- A. The operator is ultimately responsible for the runoff from the perimeter of the entire development. Regardless of the reason for the runoff, the operator is responsible for ensuring sufficient overall controls of the development.
- B. The operator shall not terminate the permit coverage until the following conditions have been met:
  - 1) After all construction activities including landscaping and lot development has been completed; and
  - 2) All lots are sold and developed.

The following exceptions to this requirement may apply:

- a. Less than 100% sold and developed at the discretion of the Director, or
  - b. Separation of the larger common plan if twenty-four (24) months have passed with no construction activity, or
  - c. All lots are developed and there are no temporary common controls for subdivision outfalls, i.e. sediment basins, large sediment traps, check dams, etc.
- 3) If lots are sold and then re-sold to a third party, permit coverage shall be obtained by each of the operators while they have ownership of the lots. The second owner is responsible for obtaining the same certification from the third owner (i.e. the certification shall pass from owner to owner).
- C. The operator shall not terminate permit coverage until the operators of all of the individual lots within the larger common plan of development or sale are notified of their permitting requirements under this general permit. In this case, the signed certification statements from each operator of individual lots shall be maintained in the stormwater pollution prevention plan for the larger common plan of development or sale. A copy of the signed certifications shall be submitted to DEQ with the NOT. The certification shall be as follows:

“I, \_\_\_\_\_, operator of an individual lot #\_\_\_\_\_, block #\_\_\_\_\_ of \_\_\_\_\_ subdivision, certify under penalty of law that I was notified by the operator of the larger common plan of the stormwater permitting requirements for my construction site(s). I understand prior to commencement of any construction activity I have to prepare and comply with a SWPPP and post the Construction Site Notice . I understand that prior to the sale of this lot to another party; I must notify the new owner of DEQ requirements and obtain this certification from the new owner.”

Signature \_\_\_\_\_

- D. The following examples are provided as clarification:

- 1) If a small portion of the original common plan of development remains undeveloped and there has been a period of time (i.e., more than 24 months) where there are no ongoing construction activities (i.e., all areas are either undisturbed or have been finally stabilized), operators may re-evaluate the original project based on the acreage remaining from the original “larger common plan of development or sale.” If less than five (5) but more than one (1) acre remains to build out the original “common plan”, coverage under the large permit may not be required. However, operators will need to comply with the terms and conditions for Small Construction Sites in the Construction General Permit. If less than one acre remains of the original common plan, the individual project may be treated as a part of a less than one acre development and no permit would be required.
- 2) If operators have a long-range master plan of development or sale where some portions of the master plan are conceptual rather than a specific plan of future development and the future construction activities would, if they occur at all, happen over an extended period of time (i.e., more than 24 months), operators may consider the “conceptual” phases of development to be separate “common plans” provided the periods of construction for the physically interconnected phases will not overlap.
- 3) Where discrete construction projects within a larger common plan of development or sale are located ¼ mile or more apart and the area between the projects is not being disturbed, each individual project can be treated as a separate plan of development or sale provided any interconnecting road, pipeline or utility project that is part of the same “common plan” is not concurrently being disturbed. For example, if an interconnecting access road or pipeline were under construction at the same time, they would generally be considered as a part of a single “common plan” for permitting purposes.
- 4) If the operator sells all the lots in the subdivision to one or more multi-lot homebuilder(s), provisions shall be made to obtain stormwater permit coverage by one of the following options:
  - a. The permit may be transferred from the first “operator” to the new/second “operator”.
  - b. A new, separate permit coverage may be obtained by the second “operator”.NOTE: If a new permit coverage is to be obtained, then it shall be obtained before the first/original permit is terminated.
- 5) If the operator retains ownership of any lots in the subdivision, the operator shall maintain permit coverage for those lots under the original permit coverage. The operator shall modify the SWPPP by stating which lots are owned and marking the lots on the site map. If there are one (1) or two (2) lots remaining and the total acreage is less than five (5) acres, the original permit coverage could be terminated and those lots could be covered as a small site.

**18. Change in Operator.** For stormwater discharges from large construction sites where the operator changes, including instances where an operator is added after the initial NOI has been submitted, the new operator shall ensure that a permit transfer form is received by DEQ at least two (2) weeks prior to the new operator beginning work at the site.

**19. Late Notifications.** A discharger is not precluded from submitting an NOI in accordance with the requirements of this part after the dates provided in Part I.B.7 of this permit. In such instances, the Director may bring an enforcement action for failure to submit an NOI in a timely manner or for any unauthorized discharges of stormwater associated with construction activity that have occurred on or after the dates specified in this permit.

**20. Failure to Notify.** The operator of a construction site who fails to notify the Director of their intent to be covered under this permit, and who potentially discharges pollutants (sediment, debris, etc.) to waters of the State without an NPDES permit, is in violation of the Arkansas Water and Air Pollution Control Act.

**21. Maintenance.** Determination of the acreage of disturbance does not typically include disturbance for routine maintenance activities on existing roads where the original line and grade, hydraulic capacity, or original purpose of the road is not being altered, nor does it include the paving of existing roads. Maintenance activities (returning to original conditions) are not



regulated under this permit unless one or more acres of underlying or surrounding soil are cleared, graded, or excavated as part of the operation.

**22. Releases in Excess of Reportable Quantities.**

A. The discharge of hazardous substances or oil in the stormwater discharge(s) from a facility shall be prevented or minimized in accordance with the applicable stormwater pollution prevention plan for the facility. This permit does not relieve the operator of the reporting requirements of 40 C.F.R. §110, §117 and §302. Where a release containing a hazardous substance or oil in an amount equal to or in excess of a reporting quantity established under either 40 C.F.R. §110, 40 C.F.R. §117, or 40 C.F.R. §302, occurs during a twenty-four (24) hour period, the following action shall be taken:

- 1) Any person in charge of the facility is required to notify the National Response Center (NRC) (800-424-8802) in accordance with the requirements of 40 C.F.R. §110, 40 C.F.R. §117, or 40 C.F.R. §302 as soon as he/she has knowledge of the discharge;
- 2) The operator shall submit within five (5) calendar days of knowledge of the release a written description of the release (including the type and estimate of the amount of material released), the date that such release occurred, and the circumstances leading to the release, and steps to be taken in accordance with Part II.B.17 of this permit to the DEQ.
- 3) The SWPPP described in Part II.A of this permit shall be modified within fourteen (14) calendar days of knowledge of the release to:
  - a. Provide a description of the release and the circumstances leading to the release; and
  - b. The date of the release;
- 4) Additionally, the SWPPP shall be reviewed to identify measures to prevent the reoccurrence of such releases and to respond to such releases, and the plan shall be modified where appropriate.

B. Spills. This permit does not authorize the discharge of hazardous substances or oil resulting from an on-site spill.

**23. Attainment of Water Quality Standards.**

The operator shall select, install, implement, and maintain control measures at the construction site and construction support activities off site that minimize the discharge of pollutants for which a stream is impaired at the discretion of the Director as necessary to protect water quality. In general, except in situations explained below, the stormwater controls developed, implemented, and updated to be considered stringent enough to ensure that discharges do not cause, have the reasonable potential to cause, or contribute to an excursion above any applicable water quality standard.

At any time after authorization, DEQ may determine that the stormwater discharges may cause, have reasonable potential to cause, or contribute to an excursion above any applicable water quality standard. If such a determination is made, DEQ will require the permittee to:

- A. Develop a supplemental BMP action plan describing SWPPP modifications to address adequately the identified water quality concerns and submit valid and verifiable data and information that are representative of ambient conditions and indicate that the receiving water is attaining water quality standards; or
- B. Cease discharges of pollutants from construction activity and submit an individual permit application.

All written responses required under this part shall include a signed certification consistent with Part II.B.9.

#### **24. Requiring an Individual Permit**

The Director may require any person eligible for coverage under the general permit to apply for and obtain an individual permit. In addition, any interested person(s) may submit an application for an individual permit. The Director may consider the issuance of individual permits according to the criteria in 40 C.F.R. §122.28(b)(3).

Coverage of the facility under this general permit is may be terminated by DEQ if the operator fails to submit or respond to the permitting process or requests for information in a timely manner.

Any operator covered under this general permit may request to be excluded from the coverage of this permit by applying for an APC&EC Rule 6 individual permit. The operator shall submit an application for an individual permit with the reasons supporting the application to DEQ. If a final, individual NPDES permit is issued to an operator otherwise subject to this general permit, the operator is required to submit a NOT. Coverage under this general permit will then be terminated no earlier than the effective date of the individual NPDES permit. Otherwise, the applicability of this general permit to the facility remains in full force and effect.

## **PART II STANDARD CONDITIONS**

Information in **Part II** is organized as follows:

**Section A:** Stormwater Pollution Prevention Plans (SWPPP):

1. Deadlines for Plan Preparation and Compliance
2. Signature, SWPPP, Inspection Reports, and Notice of Coverage (NOC)
3. Keeping SWPPP Current
4. Contents of the Stormwater Pollution Prevention Plan
5. Plan Certification

**Section B:** Standard Permit Conditions:

1. Retention of Records
2. Duty to Comply
3. Penalties for Violations of Permit Conditions
4. Continuance of the General Permit
5. Need to Halt or Reduce Activity Not a Defense
6. Duty to Mitigate
7. Duty to Provide Information
8. Other Information
9. Signatory Requirements
10. Certification
11. Penalties for Falsification of Reports
12. Penalties for Tampering
13. Oil and Hazardous Substance Liability
14. Property Rights
15. Severability
16. Transfers
17. Proper Operation and Maintenance
18. Inspection and Entry
19. Permit Actions
20. Re-Opener Clause
21. Local Requirements
22. Applicable Federal, State Requirements

## **SECTION A: STORMWATER POLLUTION PREVENTION PLANS (SWPPP)**

The operator shall prepare a SWPPP before permit coverage. The SWPPP shall follow the order outlined in Part II.A.4 & 5 below. This basic DEQ format is available through DEQ's website <https://www.adeg.state.ar.us/water/permits/npdes/stormwater/>. Other formats may be used at the discretion of the Director if the format has been approved by DEQ prior to use. The operator shall implement the SWPPP as written from initial commencement of construction activity until final stabilization is complete, with changes being made as deemed necessary by the permittee, local, state or federal officials. The plan shall be prepared in accordance with good engineering practices, by qualified personnel and shall:

- Identify potential sources of pollution which may reasonably be expected to affect the quality of stormwater discharges from the construction site and construction support activities off site;
- Identify, describe and ensure the implementation of BMPs, with emphasis on initial site stabilization, which are to be used to reduce pollutants in stormwater discharges from the construction site and construction support activities off site;
- Be site specific to what is taking place on a particular construction site;
- Ensure compliance with the terms and conditions of this permit; and
- Identify the responsible party for on-site SWPPP implementation.

### **1. Deadlines for Plan Preparation and Compliance.**

#### **A. Automatic Coverage Sites.**

The plan shall be completed prior to obtaining permit coverage and commencement of construction activities and updated as appropriate. Submittal of the NOI, permit fee and SWPPP is not required. All conditions set forth in Part II.A must be followed, and the NOC must be posted at the site prior to commencing construction activities. In addition, a copy of the SWPPP must be available at the construction site in accordance with Part II.A.2.B and D prior to commencing construction.

#### **B. Large Construction Sites.**

The plan shall be completed and submitted for review, along with an NOI and initial permit fee ten (10) business days prior to the commencement of construction activities. Submittals of updates to the plan during the construction process are required in accordance with Part I.B.6.C or if requested by the Director.

#### **C. Existing Permittees.**

Existing permittees that were permitted prior to the issuance of this renewal permit are required to update their plan as appropriate to come into compliance with the requirements contained in Part II.A.4 by the effective date of this permit.

### **2. Signature, SWPPP, Inspection Reports and Notice of Coverage (NOC).**

- A. The SWPPP and inspection reports shall be signed by the operator (or cognizant official) in accordance with Part II.B.9 and be retained at the construction site during normal business hours (8:00 A.M. – 5:00 P.M.). The inspections frequency shall be conducted in accordance with Part II.A.4.N.1.
- B. The operator shall make SWPPP and inspection reports available, upon request, to the Director, the EPA, or a State or local agency reviewing sediment and erosion plans, grading plans, or stormwater management plans, or, in the case of a stormwater discharge associated with construction activity which discharges through a municipal separate storm sewer system with an NPDES permit, to the municipal operator of the system.

- C. The Director, or authorized representative, may notify the operator at any time that the plan does not meet one or more of the minimum requirements of this Part. Within seven (7) business days of such notification from the Director (or as otherwise provided by the Director) or authorized representative, the operator shall make the required changes to the plan and submit to the Director a written certification that the requested changes have been made. DEQ may request re-submittal of the SWPPP to confirm that all deficiencies have been adequately addressed. DEQ may also take appropriate enforcement action for the period of time the operator was operating under SWPPP that did not meet the minimum requirements of this permit.
- D. The operator shall post the NOC near the main entrance of the construction site and visible to the public. The NOC shall indicate the location of the SWPPP. If the SWPPP location is changed from the initial location, the NOC shall be updated to reflect the correct location of the SWPPP.
3. **Keeping SWPPP Current.** The operator shall amend the SWPPP within seven (7) business days or whenever there is a change in design, construction, operation, or maintenance at the construction site which has or could have a significant effect on the potential for the discharge of pollutants to the waters of the State that has not been previously addressed in the SWPPP. The SWPPP shall also be modified if a determination has been made through inspections, monitoring (if required), *or* investigation by the operator, local, state, or federal officials that the discharges are causing or contributing to water quality violation or the plan proves to be ineffective in eliminating or significantly minimizing pollutants from sources identified in stormwater discharges from the construction site.
4. **Contents of the SWPPP.** The SWPPP shall include the following items:
- A. **Site Description.** SWPPP shall provide a description of the following:
- 1) A description of the nature of the construction activity and its intended use after the NOI is filed (i.e., residential subdivision, shopping mall, etc.);
  - 2) A description of the intended sequence of major activities which disturb soils for major portions of the site (e.g. grubbing, excavation, grading, infrastructure installation, etc.);
  - 3) Estimates of the total area of the site including off-site borrow and fill areas and the total area of the site that is expected to be disturbed by excavation, grading or other activities; and
  - 4) An estimate of the runoff coefficient of the site for pre- and post-construction activities and existing data describing the soil or the quality of any discharge from the site.
- B. **Responsible Parties.** The SWPPP shall identify (as soon as this information is known) all parties (i.e., General Contractors, Landscapers, Project Designers, and Inspectors) responsible for particular construction activities and services they provide to the operator to comply with the requirements of the SWPPP for the project site and construction support activities off site, and areas over which each party has control. If these parties change over the life of the permit, or new parties are added, the SWPPP shall be updated to reflect these changes.
- C. **Receiving Waters.** The SWPPP shall include a clear description of the nearest receiving water(s), or if the discharge is to a MS4, the name of the operator of the municipal system, and the ultimate receiving water(s).
- D. **Documentation of Permit Eligibility Related to the 303(d) list and Total Maximum Daily Loads (TMDL).** The SWPPP shall include information on whether or not the stormwater discharges from the site enter a waterbody that is on the most recent 303(d) list or with an approved TMDL. If the stormwater discharge does enter a waterbody that is on the most recent 303(d) list or with an approved TMDL, then the SWPPP shall address the following items:
- 1) Identification of the pollutants that the 303(d) list or TMDL addresses, specifically whether the 303(d) list or TMDL addresses sediment or a parameter that addresses sediment (such as total suspended solids, turbidity, or siltation);
  - 2) Identification of whether the operator's discharge is identified, either specifically or generally, on the 303(d) list or

any associated assumptions and allocations identified in the TMDL for the discharge; and

- 3) Measures taken by the operator to ensure that its discharge of pollutants from the site is consistent with the assumptions and allocations of the TMDL.

If DEQ determines during the review process that the proposed project will be discharging to a receiving water that is on the most recent 303(d) list or with an approved TMDL, then DEQ may notify the applicant to include additional Best Management Practices in the SWPPP.

- E. Documentation of Permit Eligibility Related to Discharges into an ERW, NSW, or ESW. The SWPPP shall include information whether or not the construction site located within a watershed of an ERW, ESW, or NSW. If the construction site is located within a watershed of an ERW, ESW, or NSW, then the SWPPP should consider using additional BMPs for these areas. The practices shall be considered during the progression of site activities and updates to the construction site SWPPP for continued protection of underground water resources.
- F. Documentation of Permit Eligibility related to potential losing stream and/or sensitive aquatic species native to these areas. The SWPPP shall include information whether or not the construction site located within a watershed of a potential losing stream, and/or sensitive aquatic species native to these areas. If the construction site is located within a watershed of a potential losing stream and/or sensitive aquatic species native to these areas, then the SWPPP shall consider using BMPs for losing stream areas. The practices should be considered during the progression of site activities and updates to the facility SWPPP for continued protection of underground water resources.
- G. Attainment of Water Quality Standards After Authorization.
  - 1) The permittee shall select, install, implement, and maintain BMPs at the construction site and at the construction support activities off site that minimize pollutants in the discharge as necessary to meet applicable water quality standards. In general, except in situations explained below, the SWPPP shall be developed, implemented, and updated to be considered as stringent as necessary to ensure that the discharges do not cause, have the reasonable potential to cause, or contribute to an excursion above any applicable water quality standard.
  - 2) At any time after authorization, DEQ may determine that the stormwater discharges may cause, have reasonable potential to cause, or contribute to an excursion above any applicable water quality standard. If such a determination is made, DEQ will require the permittee to:
    - a. Develop a supplemental BMP action plan describing SWPPP modifications to adequately address the identified water quality concerns and submit valid and verifiable data and information that are representative of ambient conditions and indicate that the receiving water is attaining water quality standards; or
    - b. Cease discharges of pollutants from construction activity and submit an individual permit application.
  - 3) All written responses required under this part shall include a signed certification (Part II.B.9).
- H. Site Map. The SWPPP shall contain a legible site map (or multiple maps, if necessary) complete to scale, showing the entire site, that identifies, at a minimum, the following:
  - 1) Pre-construction topographic view;
  - 2) Direction of stormwater flow (i.e., use arrows to show which direction stormwater will flow) and approximate slopes anticipated after grading activities;
  - 3) Delineate on the site map areas of soil disturbance and areas that will not be disturbed with regards to the construction activities and construction support activities off site under the coverage of this permit;
  - 4) Location of major structural and nonstructural controls identified in the plan;
  - 5) Location of main construction entrance and exit;

- 6) Location where stabilization practices are expected to occur;
- 7) Locations of all construction support activities off-site (i.e. materials, waste, borrow area, or equipment storage areas);
- 8) Location of areas used for concrete wash-out;
- 9) Location of all waters of the State with associated natural buffer boundary lines. Identify floodplain and floodway boundaries, if available;
- 10) Locations where stormwater is discharged to waters of the State or a municipal separate storm sewer system if applicable,
- 11) Locations where stormwater is discharged off-site (shall be continuously updated);
- 12) Areas where final stabilization has been accomplished and no further construction phase permit requirements apply;
- 13) A legend that clearly specifies any erosion and sediment control measure symbols/labels used in the site map and/or detail sheet; and
- 14) Locations of any storm drain inlets on the site and in the immediate vicinity of the site.

I. Stormwater Controls. Each plan shall include a description of appropriate controls and measures that will be installed and implemented at the construction site. The plan shall clearly describe each construction activity identified in the project description control measures associated with the construction activity and the schedule during the construction process that the measures will be implemented. Perimeter controls for the site shall be installed after the clearing and grubbing necessary for installation of the measure, but before the clearing and grubbing for the remaining portions of the site. Perimeter controls shall be actively maintained until final stabilization of those portions of the site upward of the perimeter control. Temporary controls shall be removed and properly disposed of after final stabilization. The description and implementation of controls shall address the following minimum components:

- 1) Initial Site Stabilization, Erosion, and Sediment Controls and Best Management Practices. Design, install, implement, and maintain effective erosion and sediment controls to minimize the discharge of pollutants. At a minimum the following controls and BMPs shall be designed, installed, implemented, and maintained. Therefore, the SWPPP shall address, at a minimum, the following:
  - a. For larger common plans of development or sale, only streets, drainage, utility areas, areas needed for initial construction of streets (e.g., borrow pits, parking areas, etc.) and areas needed for stormwater structures may be disturbed initially. Upon stabilization of the initial areas, additional areas may be disturbed.
  - b. The construction-phase erosion (such as site stabilization) and sediment controls (such as check dams) shall be designed to retain sediment on-site to the extent practicable.
  - c. All control measures shall be properly selected, installed, and maintained in accordance with the manufacturer's specifications, good engineering, and construction practices. If periodic inspections or other information indicates a control has been used inappropriately or incorrectly, the permittee shall replace or modify the control for site situations.
  - d. If sediment escapes the construction site, off site accumulations of sediment shall be removed before the next business day to minimize off-site impacts (e.g., to prevent fugitive sediment in a street could be washed into storm sewers by the next rain or pose a safety hazard to users of public streets). This permit does not give the authority to trespass onto other property; therefore this condition should be carried out along with the permission of neighboring land owners to remove sediment.
  - e. Sediment shall be removed from sediment traps (if used, please specify what type) or sedimentation ponds when design capacity has been reduced by 50%.
  - f. Litter, construction debris, and construction chemicals exposed to precipitation and to stormwater shall be prevented from becoming a pollutant source for stormwater discharges (e.g., screening outfalls picked up daily).
  - g. Construction support activities off site (i.e. material storage areas, overburden and stockpiles of dirt, borrow areas, etc.) used solely by the permitted project are considered a part of the project and shall be addressed in the SWPPP.

- 2) Stabilization practices. The SWPPP shall include, at a minimum, the following information:
- a. Description and Schedule: A description of initial, interim, and permanent stabilization practices, including site-specific scheduling of the implementation of the practices. Site plans shall ensure that existing vegetation is preserved where attainable and that disturbed areas are stabilized. Stabilization practices may include, but not limited to: mulching, temporary seeding, permanent seeding, geotextiles, sod stabilization, natural buffer strips, protection of trees, and preservation of mature vegetation and other appropriate measures.
  - b. Description of natural buffer areas: DEQ requires that a natural buffer zone be established between the top of stream bank and the disturbed area. The SWPPP shall contain a description of how the site will maintain natural buffer zones. For construction projects where clearing and grading activities will occur, SWPPP shall provide at least twenty-five (25) feet of natural buffer zone from any named or unnamed streams, creeks, rivers, lakes or other water bodies. The plan shall also provide at least fifty (50) feet of natural buffer zone from established TMDL waterbodies, waterbodies listed on the 303(d) list, an ERW, ESW, NSW, or other uses at the discretion of the Director. If the site will be disturbed within the recommended buffer zone, then the buffer zone area shall be stabilized as soon as possible. Exceptions from this requirement for areas such as water crossings, limited water access, and restoration of the buffer are allowed if the permittee fully documents in the SWPPP the circumstances and reasons for the buffer zone encroachment. Additionally, this requirement is not intended to interfere with any other ordinance, rule or regulation, statute or other provision of law. Please note that above-grade clearing that does not disturb the soil in the buffer zone area does not have to comply with buffer zone requirements.
  - c. Records of Stabilization: A record of the dates when grading activities occur, when construction activities temporarily or permanently cease on a portion of the site, and when stabilization measures are initiated shall be included in the plan.
  - d. Deadlines for Stabilization After Construction Activity Temporarily Ceases: Stabilization measures shall be initiated as soon as practicable in portions of the site where construction activities have temporarily ceased, but in no case more than fourteen (14) calendar days after the construction activity in that portion of the site has temporarily ceased, except:
    - (1) Where the initiation of stabilization measures by the fourteenth (14<sup>th</sup>) calendar day after construction activity temporarily ceases is precluded by snow cover, stabilization measures shall be initiated as soon as practicable.
    - (2) In arid, semiarid, and drought-stricken areas where initiating vegetative stabilization measures immediately is infeasible, alternative stabilization measures shall be employed as specified by the permitting authority.
  - e. Deadline for Stabilization After Construction Activity Permanently Ceases: Stabilization measures shall be initiated immediately in portions of the site where construction activities have permanently ceased, except:
    - (1) Where the initiation of stabilization measures immediately after construction activity permanently ceases is precluded by snow cover, stabilization measures shall be initiated as soon as practicable.
    - (2) In arid, semiarid, and drought-stricken areas where initiating vegetative stabilization measures immediately is infeasible, alternative stabilization measures shall be employed as specified by the permitting authority.
- 3) Structural Practices. A description of structural practices to divert flows from exposed soils, store flows, or otherwise limit runoff and the discharge of pollutants from exposed areas of the site to the degree attainable. Structural practices should be placed on upland soils to the degree attainable. The installation of these devices may



be subject to Section 404 of the Clean Water Act. Such practices may include but are not limited to:

- silt fences (installed and maintained);
- earthen dikes to prevent run-on;
- drainage swales to prevent run-on;
- check dams;
- subsurface drains;
- pipe slope drains;
- storm drain inlet protection;
- rock outlet protection;
- sediment traps;
- reinforced soil retaining systems;
- gabions;
- temporary or permanent sediment basins.

A combination of erosion and sediment control measures is encouraged to achieve maximum pollutant removal. Adequate spillway cross-sectional area and re-enforcement shall be provided for check dams, sediment traps, and sediment basins.

a. Sediment Basins:

- (1) For common drainage locations that serve an area with ten (10) or more acres (including run-on from other areas) draining to a common point, a temporary or permanent sediment basin that provides storage based on either the smaller of 3600 cubic feet per acre, or a size based on the runoff volume of a 10 year, 24 hour storm, shall be provided where attainable (so as not to adversely impact water quality) until final stabilization of the site. In determining whether installing a sediment basin is attainable, the operator may consider factors such as site soils, slope, available area on site, etc. Proper hydraulic design of the outlet is critical to achieving the desired performance of the basin. The outlet should be designed to drain the basin within twenty-four (24) to seventy-two (72) hours. (A rule of thumb is one square foot per acre for a spillway design.) The 24-hour limit is specified to provide adequate settling time; the seventy-two (72) hour limit is specified to mitigate vector control concerns. If a pipe outlet design is chosen for the outfall, then an emergency spillway is required. If “non-attainability” is claimed, then an explanation of non-attainability shall be included in the SWPPP. Where a sediment basin is not attainable, smaller sediment basins or sediment traps shall be used. Where a sediment basin is un-attainable, natural buffer strips or other suitable controls which are effective are required for all side slopes and down slope boundaries of the construction area. The plans for removal or final usage of the sediment basin shall be included with the description of the basin in the SWPPP.
- (2) For drainage locations serving an area less than ten (10) acres, sediment traps, silt fences, or equivalent sediment controls are required for all side slope and down slope boundaries of the construction area unless a sediment basin providing storage based on either the smaller of 3600 cubic feet per acre, or a size based on the run off volume of a 10 year, 24 hour storm is provided. The outlet should be designed to drain the basin within twenty-four (24) to seventy-two (72) hours. (A rule of thumb is one square foot per acre for a spillway design.) The 24-hour limit is specified to provide adequate settling time; the seventy-two (72) hour limit is specified to mitigate vector control concerns. If a pipe outlet design is chosen for the outfall, then an emergency spillway is required. However, in order to protect the waters of the State, the Director, at their discretion, may require a sediment basin for any drainage areas draining to a common point.

b. Velocity Dissipation Devices:

Velocity dissipation devices shall be placed at discharge locations, within concentrated flow areas serving two

or more acres, and along the length of any outfall channel to provide a non-erosive flow velocity from the structure to a water course so that the natural physical and biological characteristics and functions are maintained and protected (i.e., no significant changes in the hydrological regime of the receiving water). Please note that the use of hay-bales is not recommended in areas of concentrated flow.

J. Other Controls.

- 1) No solid materials identified in Part I.B.13.D shall be discharged to waters of the State or offsite.
- 2) Off-site vehicle tracking of sediments and the generation of dust shall be minimized through the use of a stabilized construction entrance and exit or vehicle tire washing.
- 3) For lots that are less than one (1) acre in size an alternative method may be used in addition to a stabilized construction entrance. An example of an alternative method could be daily street sweeping. This could allow for the shortening of the construction entrance.
- 4) The plan shall ensure and demonstrate compliance with applicable State or local waste disposal, temporary and permanent sanitary sewer or septic system regulations.
- 5) No liquid concrete waste shall be discharged to waters of the State. Appropriate controls to prevent the discharge of concrete washout waters shall be implemented if concrete washout will occur on-site.
- 6) No contaminants from fuel storage areas, hazardous waste storage and truck wash areas shall be discharged to waters of the State or offsite. Methods for protecting these areas shall be identified and implemented. These areas shall not be located near a waterbody, if there is a water body on or near the project.

K. Non-stormwater discharges. Sources of non-stormwater listed in Part I.B.10 of this permit that are combined with stormwater discharges associated with construction activity shall be identified in the plan. This list shall be site specific non-stormwater discharges.

L. Post-Construction Stormwater Management. The operator is required to provide a description of measures that will be installed during the construction process to control pollutants in stormwater discharges that will occur after construction operations have been completed. Structural measures shall be placed on upland soils to the degree attainable. The installation of these devices may be subject to Section 404 (Corps of Engineers) of the Clean Water Act. This permit only addresses the installation of stormwater management measures, and not the ultimate operation and maintenance of such structures after the construction activities have been completed and the site has undergone final stabilization. However, post-construction stormwater BMPs that discharge pollutants from a point source once construction is completed may need authorization under a separate DEQ NPDES permit. Such practices may include but are not limited to:

- infiltration of runoff onsite;
- flow attenuation by use of open vegetated swales and natural depressions;
- stormwater retention structures;
- stormwater detention structures (including wet ponds);
- sequential systems, which combine several practices.

A goal of at least eighty percent 80 % removal of total suspended solids from these flows which exceed predevelopment levels should be used in designing and installing stormwater management controls (where practicable). Where this goal is not met, the operator shall provide justification for rejecting each practice listed above based on site conditions.

M. Applicable State or Local Programs. The SWPPP shall be updated as necessary to reflect any revisions to applicable federal, state, or local requirements that affect the stormwater controls implemented at the site.

N. Inspections. Inspections shall be conducted by qualified personnel (provided by the operator). Inspections shall include all areas of the site disturbed by construction activity and construction support activities located off site that are exposed to precipitation and to stormwater. Inspectors shall look for evidence of, or the potential for, pollutants entering

the stormwater conveyance system. All stormwater control measures shall be observed to ensure proper installation, operation, and maintenance. Discharge locations shall be inspected to determine whether all stormwater control measures are effective in preventing significant impacts to waters of the State or offsite, where accessible. Where discharge locations are inaccessible, nearby downstream locations shall be inspected to the extent that such inspections are practicable. Locations where vehicles enter or exit the site shall be inspected for evidence of off-site sediment tracking. Inspections may not be required if the remaining lot(s) within a larger common plan of development or sale disturb less than one acre of land. In addition, inspections may not be required on a completed section of a linear project if final stabilization has been completed for that section. Stabilized areas of the project shall be indicated in the SWPPP and site map and show what date they were stabilized. The operator shall ensure that no sediment will leave the lot(s) that are stabilized. These lots shall be identified within the SWPPP and show what date they were stabilized. If the operator is unable to ensure this, then inspections shall continue.

- 1) Inspection Frequency. Inspections shall be conducted in accordance with one of the following schedules listed below. The schedule **must be specified** in the SWPPP.
  - a. At least once every seven (7) calendar days, or
  - b. At least once every fourteen (14) calendar days and within twenty-four (24) hours of the end of a storm event of 0.25 inches or greater (a rain gauge must be maintained on-site).
  
- 2) Inspection Form. The DEQ inspection form should be used for all inspections. The inspection form shall include all stormwater controls that are being used on site as well as at construction support activities off site. The form is available on DEQ's website [www.adeq.state.ar.us](http://www.adeq.state.ar.us). If a different form is used, it shall at a minimum contain the following information:
  - a. Inspector name and title;
  - b. Date of Inspection;
  - c. Amount of rainfall and days since last rain event (only applicable to Part II.A.4.N.1.b);
  - d. Approximate beginning and duration of the storm event;
  - e. Description of any discharges during inspection;
  - f. Locations of discharges of sediment/other pollutants;
  - g. Locations of BMPs in need of maintenance or where maintenance was performed;
  - h. If the BMPs are in working order and if maintenance is required (including when scheduled and completed);
  - i. Locations that are in need of additional controls;
  - j. Location and dates when major construction activities begin, occur or cease;
  - k. Signature of qualified signatory official, in accordance with Part II.B.9.

Additional information may be added to the inspection report at the permittee's discretion.

- 3) Inspection Records. Each report shall be retained as part of the SWPPP for at least three (3) years from the date the site is finally stabilized. Each report shall be signed and have a certification statement in accordance with Parts II.B.9 and 10 of this permit.
  
- 4) Winter Conditions. Inspections will not be required at construction sites nor the construction support activities located off site where snow cover exists over the entire site for an extended period, and melting conditions do not exist. If there is any runoff from the site at any time during snow cover, melting conditions are considered to be existent at the site and this inspection waiver does not apply. Regular inspections, as required by this permit, are required at all other times as specified in this permit. If winter conditions prevent compliance with the permit, documentation of the beginning and ending date of winter conditions shall be included in the SWPPP.
  
- 5) Adverse Weather Conditions. Adverse conditions are those that are dangerous or create inaccessibility for personnel, such as local flooding, high winds, or electrical storms, or situations that otherwise make inspections

impractical, such as extended frozen conditions. When adverse weather conditions prevent the inspection of the site, an inspection shall be completed as soon as is safe and feasible. If adverse weather conditions prevent compliance with the permit, documentation of the beginning and ending date of adverse weather conditions shall be included in the SWPPP.

- O. ***Maintenance.*** A description of procedures to maintain vegetation, erosion and sediment control measures and other protective measures in good, effective operating condition shall be outlined in the plan. Any repairs that are needed based on an inspection shall be completed, when practicable, before the next storm event, but not to exceed a period of three (3) business days of discovery, or as otherwise directed by state or local officials. However, if conditions do not permit large equipment to be used, a longer time frame is allowed if the condition is thoroughly documented on the inspection form. Maintenance for manufactured controls shall be done at a minimum of the manufacturer's specifications. Maintenance for non-manufactured controls, i.e. check dams and sediment traps, shall be done when 50% of treatment capacity remains.
  - P. ***Employee Training.*** The permittee/operator is responsible for training personnel, who are responsible for implementing activities identified in the SWPPP, on the components and requirements of the SWPPP and the requirements of the general permit. This includes contractors and subcontractors. Training shall be given by a knowledgeable and qualified trainer. The SWPPP shall identify periodic dates for such training for all personnel and records of training shall be maintained with the SWPPP. Training records that are maintained electronically (i.e. database, etc.) do not need to be maintained with the SWPPP, but shall be accessible upon request. Formal training classes given by Universities or other third-party organizations are not required but recommended for qualified trainers; the permittee is responsible for the content of the training being adequate for personnel to implement the requirements of the permit.
5. **Plan Certification.** The SWPPP Certification shall be signed by either the operator or the cognizant official identified on the NOI. All documents required by the permit and other information requested by the Director shall be signed by operator or by a duly authorized representative of the operator (Please see Part II.B.10 below for certification).

## SECTION B: STANDARD PERMIT CONDITIONS

### 1. Retention of Records.

- A. The operator shall retain records of all Stormwater Pollution Prevention Plans, all inspection reports required by this permit, and records of all data used to complete the NOI to be covered by this permit for a period of at least three (3) years from the date the NOT letter is signed by DEQ. This period may be extended by request of the Director at any time.
- B. The operator shall retain a signed copy of the SWPPP and inspection reports required by this permit at the construction site from the date of project initiation to the date of final stabilization.

### 2. Duty to Comply. The operator shall comply with all conditions of this permit. Any permit noncompliance constitutes a violation of the federal Clean Water Act and the Arkansas Water and Air Pollution Control Act and is grounds for: enforcement action; permit termination, revocation and re-issuance, or modification; or denial of a permit renewal application.

### 3. Penalties for Violations of Permit Conditions. The Arkansas Water and Air Pollution Control Act (Ark. Code Ann. 8-4-101 et seq.) provides that any person who violates any provisions of a permit issued under the Act shall be guilty of a misdemeanor and upon conviction thereof shall be subject to imprisonment for not more than one (1) year, or a criminal penalty of not more than twenty five thousand dollars (\$25,000) or by both such fine and imprisonment for each day of such violation. Any person who violates any provision of a permit issued under the Act may also be subject to civil penalty in such amount as the court shall find appropriate, not to exceed ten thousand dollars (\$10,000) for each day of such violation. The fact that any such violation may constitute a misdemeanor shall not be a bar to the maintenance of such civil action. Any person that purposely, knowingly, or recklessly causes pollution of the water of the state in a manner not otherwise permitted by law and thereby places another person in imminent danger of death or serious bodily injury shall be guilty of a felony and shall be subject to imprisonment, a fine not more than two hundred fifty thousand dollars (\$250,000), or both such fine and imprisonment.

### 4. Continuance of the General Permit. Permittees wishing to continue coverage under this general permit shall submit a Renewal NOI (see Part I.B.4 for where to submit documentation) up to 180 days prior to the expiration date, but no later than thirty (30) days prior to the expiration date. No additional fee is required to be submitted along with the Renewal NOI.

An expired general permit continues in force and effect until a new general permit is issued. If this permit is not re-issued or replaced prior to the expiration date, it will be administratively continued in accordance with Ark. Code Ann. § 8-4-203(m) and remain in force and effect. If a permittee was granted permit coverage prior to the expiration date, the permittee will remain covered by the continued permit until the earliest of:

- A. The effective date of the re-issuance or replacement of this permit and a timely submittal of a renewal NOI by the operator; or
- B. The operator's submittal and DEQ approval of a NOT; or
- C. Issuance and effectiveness of an individual permit for the project's discharges and completion of item B of this section (see Part I.B.24); or
- D. A formal permit decision by DEQ to not re-issue this general permit, at which time operators must seek coverage under an alternative permit (see Part I.B.24).

Small site operators are responsible for ensuring that the site is in compliance with any changes or updates of this general permit by reviewing DEQ's website at:

<https://www.adeq.state.ar.us/water/permits/npdes/stormwater/>

5. **Need to Halt or Reduce Activity Not a Defense.** It shall not be a defense for an operator in an enforcement action that it would have been necessary to halt or reduce the permitted activity in order to maintain compliance with the conditions of this permit.
6. **Duty to Mitigate.** The operator shall take all reasonable steps to minimize or prevent any discharge or sludge use or disposal in violation of this permit which has reasonable likelihood of adversely affecting human health or the environment.
7. **Duty to Provide Information.** The operator shall furnish to the Director, an authorized representative of the Director, the EPA, a State or local agency reviewing sediment and erosion plans, grading plans, or stormwater management plans, or in the case of a stormwater discharge associated with industrial activity which discharges through a MS4 with an NPDES permit, to the municipal operator of the system, within a reasonable time, any information which is requested to determine compliance with this permit.
8. **Other Information.** When the operator becomes aware that he or she failed to submit any relevant facts or submitted incorrect information in the NOI or in any other report to the Director, he or she shall promptly submit such facts or information.
9. **Signatory Requirements.** All NOIs, reports, or information submitted to the Director shall be signed and certified by the operator.

A. All NOI shall be signed as follows:

- 1) **For a corporation:** by a responsible corporate officer. For purposes of this section, a responsible corporate officer means:
  - a. A president, treasurer, or vice-president of the corporation in charge of a principal business function, or any other person who performs similar policy or decision-making functions for the corporation; or
  - b. The manager of one or more manufacturing, production, or operating facilities, provided, the manager is authorized to make management decisions which govern the operation of the regulated facility including having the explicit or implicit duty of making major capital investment recommendations, and initiating and directing other comprehensive measures to ensure long term environmental compliance with environmental laws and regulations; the manager can ensure that the necessary systems are established or actions taken to gather complete and accurate information for permit application requirements; and where authority to sign documents has been assigned or delegated to the manager in accordance with corporate procedures.
- 2) **For a partnership or sole proprietorship:** by a general partner or the proprietor, respectively;
- 3) **For a municipality, State, Federal or other public agency:** by either a principal executive or ranking elected official. For purposes of this section, a principal executive officer of a Federal agency includes:
  - a. The chief executive officer of the agency; or
  - b. A senior executive officer having responsibility for the overall operations of a principal geographic unit of the agency.

B. All reports required by the permit and other information requested by the Director shall be signed by a person described

above or by a duly authorized representative of that person. A person is a duly authorized representative only if:

- 1) The authorization is made in writing by a person described above and submitted to the Director;
- 2) The authorization specifies either an individual or a person having responsibility for the overall operation of the regulated facility or activity, such as the position of plant manager, operator of a well or a well field, superintendent, or position of equivalent responsibility, or position of equivalent responsibility for environmental matters for the company (A duly authorized representative may thus be either a named individual or any individual occupying a named position); and
- 3) Changes to authorization. If an authorization under this Part is no longer accurate because a different individual or position has responsibility for the overall operation of the facility, a new authorization satisfying the above requirements shall be submitted to the Director prior to or together with any reports, information, or applications to be signed by an authorized representative.

**10. Certification.** Any person signing a document under this section shall make the following certification:

"I certify under penalty of law that this document and all attachments such as Inspection Form were prepared under my direction or supervision in accordance with a system designed to ensure that qualified personnel properly gather and evaluate the information submitted. Based on my inquiry of the person or persons who manage the system, or those persons directly responsible for gathering the information, the information submitted is, to the best of my knowledge and belief, true, accurate, and complete. I am aware that there are significant penalties for submitting false information, including the possibility of fine and imprisonment for knowing violations."

Note: For this permit only, "this document" refers to the Stormwater Pollution Prevention Plan, "attachments" refers to the site map and inspection forms, and "system" is referencing the project site.

- 11. Penalties for Falsification of Reports.** The Arkansas Water and Air Pollution Control Act provides that any person who knowingly makes any false statement, representation, or certification in any application, record, report, plan or other document filed or required to be maintained under this permit shall be subject to civil penalties specified in Part II.B.3 of this permit and/or criminal penalties under the authority of the Arkansas Water and Air Pollution Control Act (Ark. Code Ann. 8-4-101 et seq.).
- 12. Penalties for Tampering.** The Arkansas Water and Air Pollution Control act provides that any person who falsifies, tampers with, or knowingly renders inaccurate any monitoring device or method required to be maintained under the Act shall be guilty of a misdemeanor and upon conviction thereof shall be subject to imprisonment for not more than one (1) year or a fine of not more than twenty five thousand dollars (\$25,000) or by both such fine and imprisonment.
- 13. Oil and Hazardous Substance Liability.** Nothing in this permit shall be construed to preclude the institution of any legal action or relieve the operator from any responsibilities, liabilities, or penalties to which the operator is or may be subject under Section 311 of the Clean Water Act or Section 106 of the Comprehensive Environmental Response, Compensation, and Liability Act (CERCLA).
- 14. Property Rights.** The issuance of this permit does not convey any property rights of any sort or any exclusive privileges, nor does it authorize any injury to private property, any invasion of personal rights, or any infringement of Federal, State, or local laws or regulations.
- 15. Severability.** The provisions of this permit are severable. If any provisions of this permit or the application of any provision of this permit to any circumstance is held invalid, the application of such provisions to other circumstances and the remainder of this permit shall not be affected thereby.

**16. Transfers.** This permit is not transferable to any person except after notice to the Director. A transfer form shall be submitted to DEQ as required by this permit.

**17. Proper Operation and Maintenance.** The operator shall at all times:

- A. Properly operate and maintain all systems of treatment and control (and related appurtenances) which are installed or used by the operator to achieve compliance with the conditions of this permit. This provision requires the operation of backup or auxiliary facilities or similar systems which are installed by an operator only when the operation is necessary to achieve compliance with the conditions of the permit.
- B. Provide an adequate operating staff which is duly qualified to carry out operation, inspection, maintenance, and testing functions required to ensure compliance with the conditions of this permit.

**18. Inspection and Entry.** The operator shall allow the Director, the EPA, or an authorized representative, or, in the case of a construction site which discharges to a municipal separate storm sewer, an authorized representative of the municipal operator of the separate sewer system receiving the discharge, upon the presentation of credentials and other documents as may be required by law, to:

- A. Enter upon the operator's premises where a regulated facility or activity is located or conducted, or where records shall be kept under the conditions of this permit;
- B. Have access to and copy, at reasonable times, any records that shall be kept under the conditions of this permit;
- C. Inspect at reasonable times any facilities or equipment, including monitoring and control equipment and practices or operations regulated or required by the permit;
- D. Sample or monitor at reasonable times, for the purposes of assuring permit compliance or as otherwise authorized by the CWA, any substances or parameters at any location on the permitted property.

**19. Permit Actions.** This permit may be modified, revoked and reissued, or terminated for any cause including, but not limited to, the following;

- A. Violation of any terms or conditions of this permit;
- B. Obtaining this permit by misrepresentation or failure to fully disclose all relevant facts;
- C. A change in any conditions that requires either a temporary or permanent reduction or elimination of the authorized discharge;
- D. A determination that the permitted activity endangers human health or the environment and can only be regulated to acceptable levels by permit modification or termination; or
- E. Failure of the operator to comply with the provisions of DEQ Rule 9 (Fee Rule). Failure to promptly remit all required fees shall be grounds for the Director to initiate action to terminate this permit under the provisions of 40 C.F.R. §122.64 and §124.5(d), as adopted by reference in DEQ Rule 6, and the provisions of DEQ Rule 8.

**20. Re-Opener Clause.**

- A. If there is evidence indicating potential or realized impacts on water quality due to any stormwater discharge associated with industrial activity covered by this permit, the operator of such discharge may be required to obtain an individual permit or an alternative general permit in accordance with Part I.B.24 of this permit, or the permit may be modified to include different limitations and/or requirements.
- B. Permit modification or revocation will be conducted in accordance with the provisions of 40 C.F.R. §122.62, §122.63, §122.64 and §124.5, as adopted by reference in DEQ Rule 6.

**21. Local Requirements.** All dischargers shall comply with the lawful requirements of municipalities, counties, drainage districts, and other local agencies regarding any discharges of stormwater to storm drain systems or other water sources under their jurisdiction, including applicable requirements in municipal stormwater management programs developed to



comply with the DEQ permits. Dischargers shall comply with local stormwater management requirements, policies, or guidelines including erosion and sediment control.

22. **Applicable Federal, State, or local Requirements.** Permittees are responsible for compliance with all applicable terms and conditions of this permit. Receipt of this permit does not relieve any operator of the responsibility to comply with any other applicable federal, state or local statute, ordinance policy, or regulation. Nothing in this permit shall be construed to preclude the institution of any legal action or enforcement actions or relieve the permittee from any responsibilities, liabilities, or penalties established pursuant to any applicable local state, or federal law or regulation.