



Bryant Planning Commission Meeting
Monday, March 12th, 2018
6:00 p.m.
Boswell Municipal Complex - City Hall Courtroom

Agenda

CALL TO ORDER

- Chairman to call the meeting to order.
- Secretary calls roll

APPROVAL OF MINUTES

Documents:

Bryant Planning Commission Meeting Minutes 2-12-18.pdf

ANNOUNCEMENTS

DRC REPORT

Reynolds Road Animal Clinic

Requesting Sign Permit Approval - **Approved**

Documents:

0017-APP-001.pdf

Indian Springs Baptist Church

Eric Krebs - Requesting Site Plan Approval for Discipleship Addition - **Site Plan Approved But Not Facade**

Documents:

ISBC Commercial Checklist.pdf
ISBC Civil Design - Addition.pdf

Relyance Bank

Requesting Sign Permit Application Approval - **Sign Permit Approved, Site Plan Not Approved**

Documents:

Proposed Site Plan 1.pdf
Relyance Application.pdf
Relyance Bank.pdf

- . **Bryant Planning And Community Development Department**
Changes to the Bryant Zoning Code, Sections 5.7, 2-3, and 17 - **Recommend Approval**

- . **Freedom Ink - 5313 Highway 5 North**
Requesting Sign Permit Approval - **Approved**

Documents:

Freedom Ink Signs.pdf

- . **Bryant School District**
Requesting Site Plan Approval for Temporary Classrooms - **Approved**

- . **23277 I-30 Billboard**
Greg Criner - Requesting Billboard Permit Application Approval - **Approved**

Documents:

23277 I-30 Billboard.pdf

- . **22461 I-30 Billboard**
Custom Advertising - Landers Corp. Plaza - Requesting Sign Permit Application Approval - **Approved**

Documents:

22461 I-30 Billboard.pdf

DIRECTOR'S REPORT

Truett Smith - Director of Planning and Community Development

NEW BUSINESS

- . **Indian Springs Baptist Church**
Requesting Approval of Facade of Building as Non-Standard Building

Documents:

ISBC Letter 3-6-18.pdf
Inidian Springs Baptist Church Facade.pdf

- . **The Stables**
Alan Schrader and Eric Richardson - Requesting Waiver from Master Transportation Plan

Documents:

The Stables Waiver.pdf

PUBLIC HEARING

- . **Bryant Planning And Community Development Department**
Changes to the Bryant Zoning Code, Sections 5.7, 2-3, and 17

Documents:

Zoning Changes Various 3.12.2018.pdf

ADJOURNMENT



Bryant Planning Commission Meeting
Monday, March 12th, 2018
6:00 p.m.
Boswell Municipal Complex-City Hall Courtroom

UNAPPROVED MINTUES FOR 2/12/17 MEETING
2 Pages

CALL TO ORDER:

- Chairman Jim Erwin Calls Meeting To Order
- Commissioners Present: Brunt, Erwin, Burgess, Penfield, Poe, Statton, Mayfield, and Johnson.

APPROVAL OF MINTUES:

Approval of the January 8th, 2017 Planning Commission Minutes.

Action taken: Motion made to approve minutes with corrections to commissioners name by Commissioner Statton and seconded by Commissioner Poe. Voice vote: 8 yeas and 0 nay.

DRC REPORT

US Nails And Spa - Requesting Sign Permit Application Approval

Sally's Body Shop - Requesting Sign Permit Application Approval - Approved

River Valley Tractor - Requesting Sign Permit Application Approval - Approved

Planning & Community Development Department - Bryant Zoning Code Changes - Recommend Approval

Mills Park Restroom - Requesting Site Plan Approval - Recommend Approval

Bishop Park Admin And Maintenance Building - Requesting Site Plan Approval - Recommend Approval

Big Dog Gym - Requesting Change of Commercial Site Plan - Approved

DIRECTOR'S REPORT

Truett Smith - Director of Planning and Community Development

Director informs commission of the following:

- The project on Boone Road that was previously being pursued by Eric Richardson is no longer being pursued
- City Council approved a grant for a roundabout at Hilltop, Hilldale and Bryant Parkway
- City Council put the Zoning Code recommendation from last meeting on 1st reading only
- City Council approved the Master Lighting Plan

NEW BUSINESS

Bishop Park Administration And Grounds Building - Ken King - Requesting Site Plan Approval

Chairman Erwin Calls for a roll call vote. 8 yeas and 0 nay.

Mills Park Restroom - Ken King - Requesting Site Plan Approval

Chairman Erwin Calls for a roll call vote. 8 yeas and 0 nay.

PUBLIC HEARING

Planning & Community Development Department

Bryant Zoning Code Changes

Commissioner Penfield makes a motion to approve the propose changes, excluding section 15.6, Commissioner Poe seconds.

Chairman Erwin Calls for a roll call vote. 8 yeas and 0 nay.

ADJOURNMENT

Motion made to adjourn by Commissioner Penfield, seconded by Commissioner Poe.

Approval of the minutes for February 12th 2018 Bryant Planning Commission meeting was approved on March 12th 2018.

_____ Date: _____2018
Chairman Jim Erwin

_____ Date: _____2018
Secretary Truett Smith

City of Bryant, Arkansas
Code Enforcement, Permits and Inspections
312 Roya Lane
Bryant, Ar 72022
501-943-0943

SIGN PERMIT APPLICATION

Applicants are advised to read the sign ordinance prior to completing and signing this form. The Sign Ordinance is available at www.cityofbryant.com

Site plan showing placement of sign and any existing signs on the property. A rendering of sign showing correct dimensions of all signs are required with application. Additional documentation may be required by Sign Administrator.

Date: 2/20/18

Note: Electrical permits may be Required, Please contact the Permits Office at 501-943-0943 for more information.

SIGN CO. OR

SIGN OWNER

Name Susan E. Belt, Inc.

Address 4405 Catskill Ave

City, State, Zip Benton AR 72019

Phone (501) 258-3784

Alternate Phone (501) 847-5300

PROPERTY OWNER

Name Belt Holdings LLC

Address 4405 Catskill Avenue

City, State, Zip Benton AR 72019

Phone (501) 258-3784

Alternate Phone (501) 847-5300

GENERAL DETAILS

Name of Business Reynolds Rd Animal Clinic

Address/Location of sign 2201 N. Reynolds Road

Sign dimensions (height, length, width) 4' circles x 2

Zoning Classification C1

SIGN TYPE

Pole Monument

Wall X2

Other (type) _____

Total sq. ft. 48

Aggregate Surface Area (total all signs) on ends of building & replace old/damaged sign out front

Pole: Height of sign from lot surface: Bottom 30 inches Top 62 inches

READ CAREFULLY BEFORE SIGNING

I, Susan E. Belt, do hereby certify that all information contained within this application is true and correct. I fully understand that the terms of the Sign Ordinance supersede the Sign Administrator's approval and that all signs must fully comply with all terms of the Sign Ordinance regardless of approval. I further certify that the proposed sign is authorized by the owner of the property and that I am authorized by the property owner to make this application. I understand that no sign may be placed in any public right of way. I understand that I must comply with all Building and Electrical Codes and that it is my responsibility to obtain all necessary permits.

Susan E. Belt
Applicant's Signature

2/20/18
Date

Sign Administrator (or Designee) Approval

Date

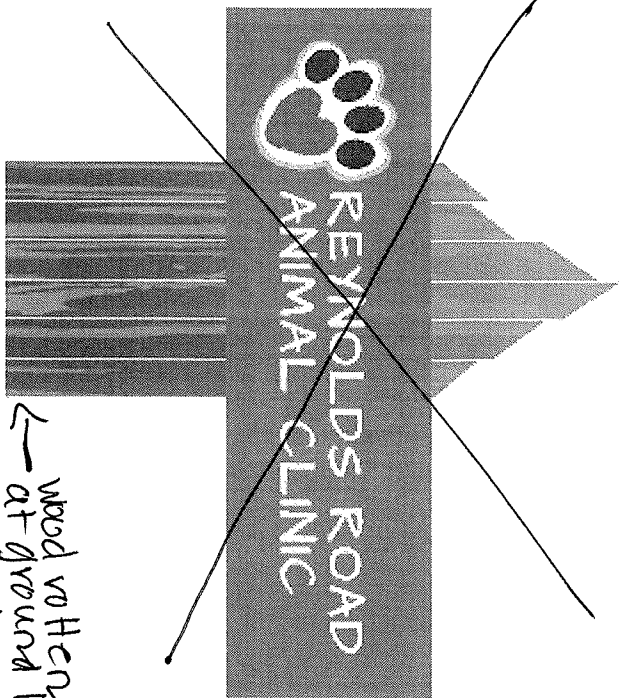

wood rotten
at ground level
replacing with



* replacing existing 32" x 60" oval signs on ends of building
* updated logo 4' circle (12 sq ft each)

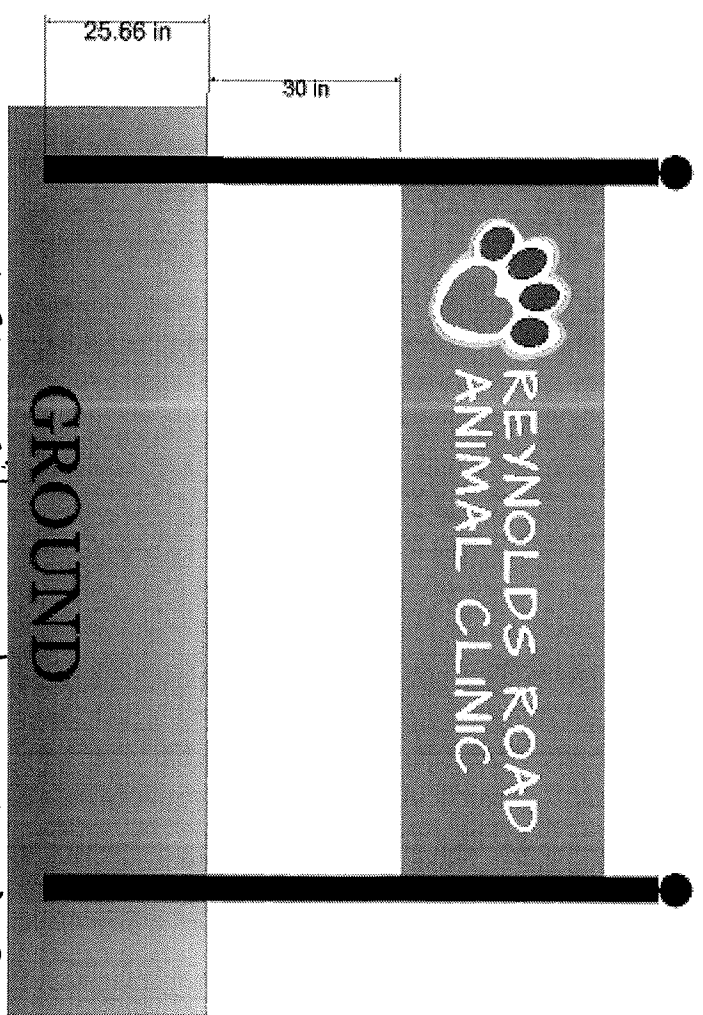

* same site as existing sign in front
* same size as existing sign (31" x 108")

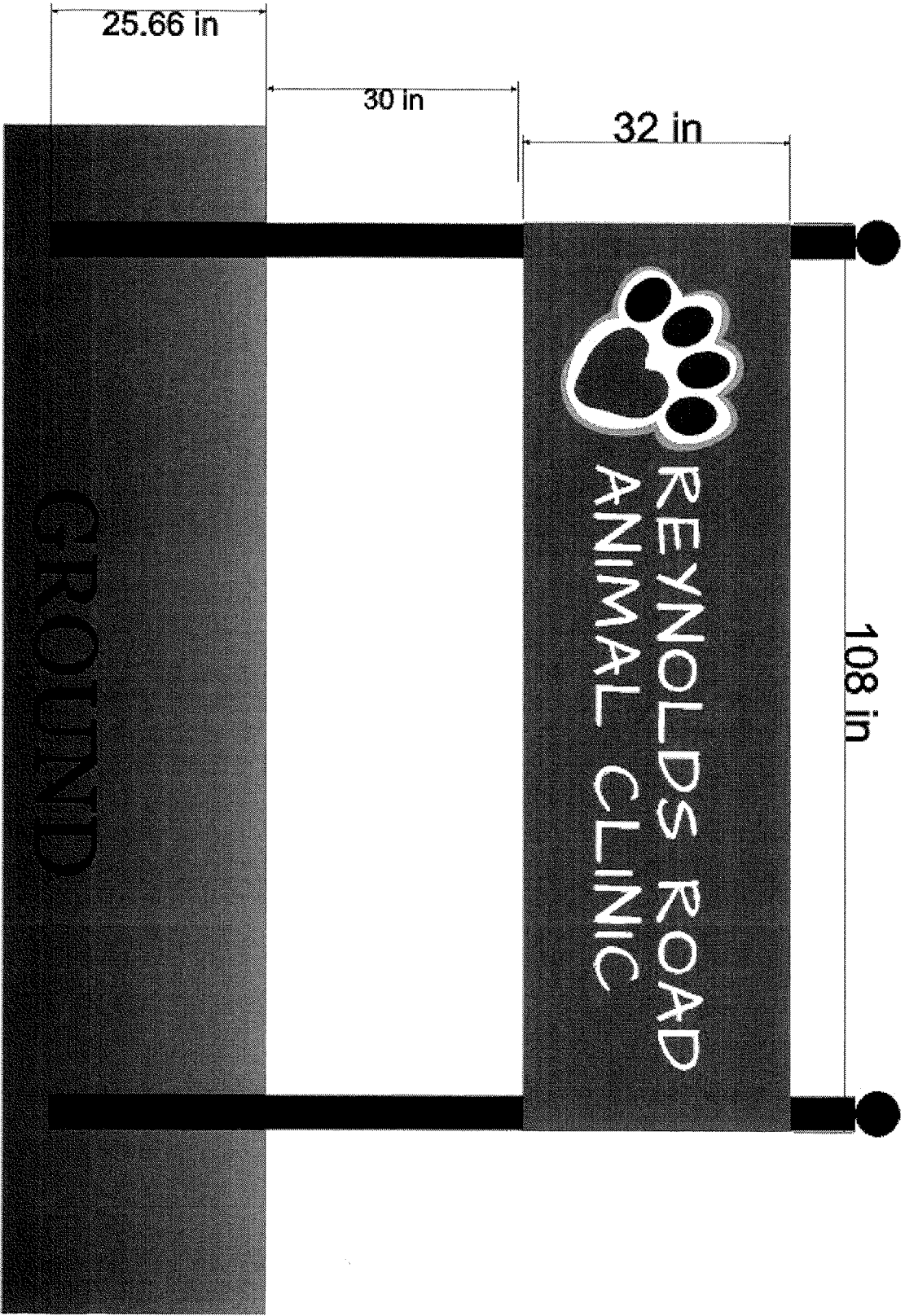

25.66 in

30 in

32 in

108 in

GROUND

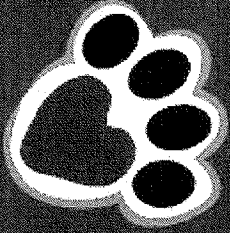

REYNOLDS ROAD
ANIMAL CLINIC

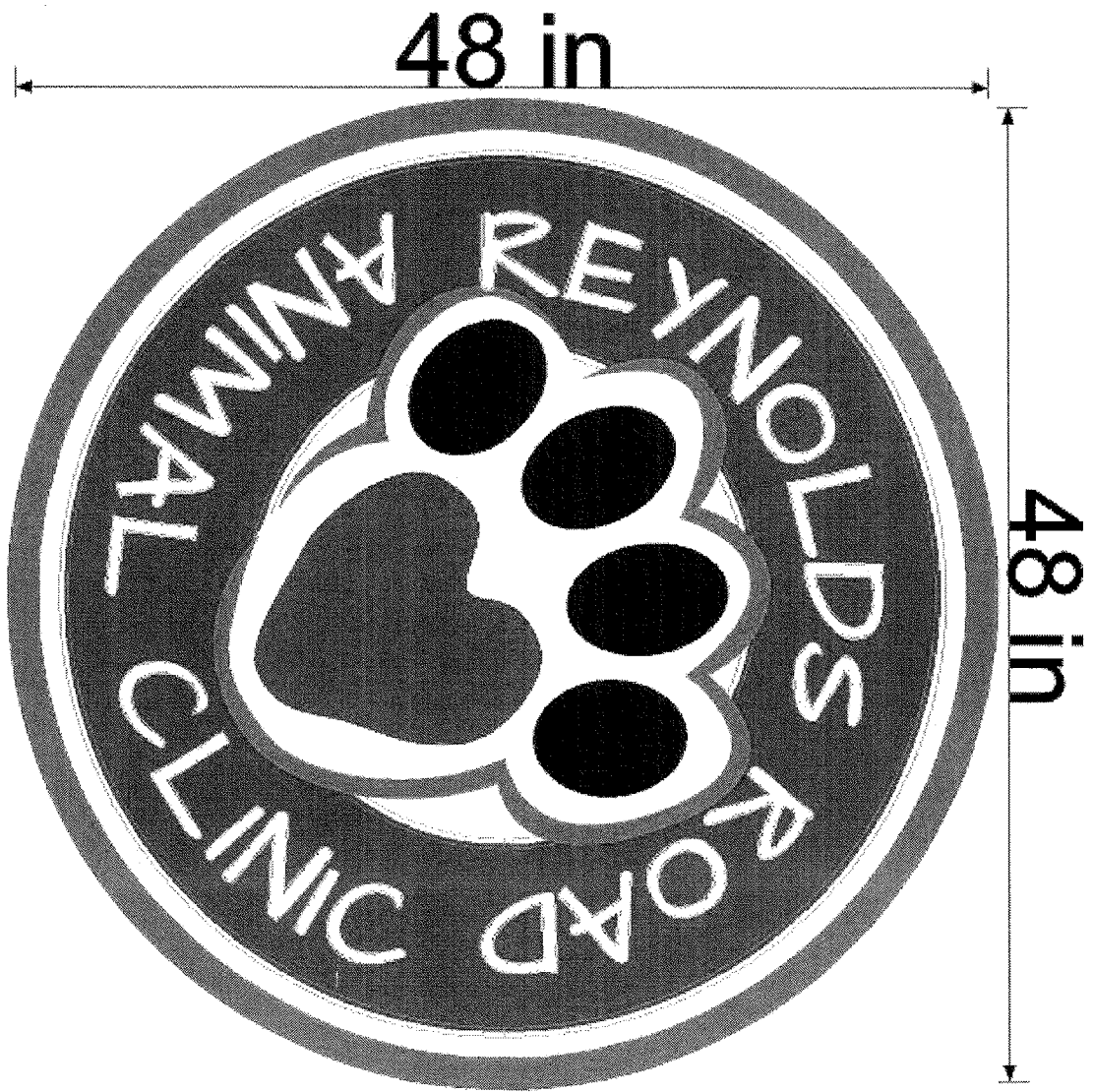

Bryant Planning Commission

SMALL SCALE DEVELOPMENT COMMERCIAL BUILDING CHECKLIST

CITY OF BRYANT
210 SW 3RD STREET
BRYANT, AR 72022
501-943-0309

PC MEETING DATE: THURSDAY OF EACH WEEK
TIME: 9:00 A.M.
PLACE: ADMINISTRATION CONFERENCE ROOM-BRYANT OFFICE COMPLEX
AGENDA DEADLINE: 5:00 P.M. FRIDAY PRIOR TO SCHEDULED MEETING DATE

REQUIREMENTS FOR SUBMISSION

1. COMPLETED CHECKLIST (SUBDIVISION OR BUILDING)
2. ADA/ABA FORM COMPLETED
3. TWO FULL SETS OF BUILDING PLANS
4. 12 FOLDED COPIES OF SITE PLAN (MINIMUM SIZE 17" X 34") THAT INCLUDES THE FOLLOWING:
 - A. VICINITY MAP
 - B. LEGAL DESCRIPTION
 - C. LANDSCAPING PLAN
5. 12 FOLDED COPIES OF FLOOR PLAN
6. 12 COPIES OF FRONT AND REAR BUILDING ELEVATIONS
7. A CD IN .PDF FORMAT
8. COPY OF ADEQ STORMWATER POLLUTION PREVENTION PLAN FOR PROPERTY PARCEL CONTAINING ONE ACRE OR LARGER.
9. 2 COPIES OF STORMWATER DETENTION PLAN
10. \$250.00 FOR STORMWATER DETENTION AND DRAINAGE PLAN REVIEW

ALL REQUIREMENTS LISTED ABOVE MUST BE COMPLETED AND ATTACHED BEFORE SUBMITTING APPLICATION TO BE PLACED ON THE PLANNING COMMISSION AGENDA.

NOTE: WHEN MAKING CHANGES TO AN APPROVED SITE PLAN, A REVISED SITE PLAN MUST BE SUBMITTED TO THE BRYANT PLANNING COMMISSION FOR APPROVAL. THIS MUST BE DONE PRIOR TO IMPLEMENTATION. FAILURE TO COMPLY WILL RESULT IN PENALTIES/FINES BEING IMPOSED IN ACCORDANCE WITH CITY ORDINANCES.

I HAVE COMPLIED WITH THE REQUIREMENTS LISTED ABOVE AND HAVE CHECKED ALL OF THE BOXES ON THE CHECKLIST WHICH APPLY TO THIS PROJECT SUBMITTAL.

SIGNATURE

DATE

City of Bryant Commercial Building Checklist

Name of Development Indian Springs Baptist Church - Discipleship Building Addition

Site Location 23581 I-30, Bryant, AR 72022 Current zoning C-2

Owner Indian Springs Baptist Church Phone 501-847-0936

I. BASIC INFORMATION NEEDED ON THE SITE PLAN

- ▲ 1. Name of Development
- ▲ 2. Current zoning
- ▲ 3. Name and Address of owner of Record
- ▲ 4. Name and address of the architect, landscape architect, engineer, surveyor, or other person involved in the preparation of the plan
- ▲ 5. Date of preparation of the plan
- ▲ 6. Vicinity map locating streets, highways, section lines, railroad, schools, & parks within ½ mile
- ▲ 7. Legal description of the property with exact boundary lines
- ▲ 8. North arrow & Scale
- ▲ 9. Identification of any land areas within the 100 year floodplain and within the 100 year floodway
- ▲ 10. Lot area in square feet
- ▲ 11. Show scale (not less than 1" = 100') (paper size minimum 17" X 34")
- ▲ 12. Existing streams, drainage channels, and other bodies of water
- ▲ 13. Drainage easements for stormwater run-off and detention shown & labeled
- ▲ 14. Location and name of existing streets
- ▲ 15. Show source of water supply
- ▲ 16. Show location of waste water connection to municipal system & sanitary sewer layout
- ▲ 17. Fire Hydrant placement
- ▲ 18. Proposed location of buildings and other structures, parking areas, drives, loading areas, service areas, alleys, walks, screening, and public streets
- ▲ 19. Sufficient dimensions to indicate relationship between buildings, property lines, parking areas and other elements of the plan
- ▲ 20. Extent and character of proposed landscaping. Common and/or Botanical plant names and sizes of new vegetation must be clearly indicated.
- ▲ 21. Location, massing and pattern of existing vegetation to be retained
- ▲ 22. Existing structures on the site
- ▲ 23. Pedestrian and vehicular access points, sidewalks, crosswalks, etc.
- ▲ 24. Typical building elevations depicting the style, size and exterior construction materials of the buildings proposed. Where several building types are proposed on the plan, such as apartments and commercial buildings, a separate sketch shall be prepared for each type. The elevations shall be drawn at a minimum scale of 1/16" to a foot and must show adjoining context.
- ▲ 25. Any variance approvals

II ADDITIONAL INFORMATION NEEDED, BUT NOT ON THE SITE PLAN

COMMERCIAL BUILDING WORKSHEET

	Yes	No
Site is compatible with Master Street Plan	X	
Proposed improvement is within building line setbacks Matching existing. Front _____ft. Side _____ft. CNR Side <u>N/A</u> ft. Back _____ft.	X	
Parking requirements can be satisfied Church Parking based on estimated need. Floor Space _____sq.ft. divided by 300 = _____ (no. of parking spaces required)	X	
Improvement is outside 100 year flood plain (if answer is no - Provide 404 Permit for site)	X	
Lowest building floor level and all mechanical equipment are above FEMA 100 year flood elevation	X	
Will there be a dumpster located on the site? Will use existing		X
Will there be a construction site office?		X
Have you made "One Call"?	X	
Structure and site complies with ADA (Americans with Disability Act) and ABA (Architectural Barriers Act) Accessibility Guidelines	X	
Design complies with Arkansas Plumbing Code and National Electric Code requirements	X	
Foundation and structure meet earthquake requirements for Zone 1.	X	
Structure meets Arkansas Energy Code for specified use.	X	
Complies with Arkansas Fire Prevention Code	X	
Complies with International Code Council regulations	X	
Will a Site Clearance Permit be required? (City Ordinance 2002-03) Existing site.		X
Are you granted any variances by the Board of Adjustment?		X
If you have been granted a variance please explain in detail:		

III. LANDSCAPING COMPLIANCE WITH REQUIREMENTS

	YES	NO
No planting within 5 feet of a fire hydrant	N/A _____	_____
Spacing will be 40' between trees	N/A _____	_____
Tree must be a minimum 3" in diameter at the base and 12' + tall	N/A _____	_____
Existing trees meeting the minimum size can be counted to meet above criteria	N/A _____	_____
No trees can be planted within 30 feet of a property corner or driveway	N/A _____	_____
Shrubs along street right-of-way lines cannot exceed 30 inches in height	N/A _____	_____

IV. SITE COVERAGE COMPLIANCE WITH REQUIREMENTS

(FOR YOUR CONVENIENCE WE HAVE LISTED THE THREE COMMERCIAL ZONING SITE COVERAGE REQUIREMENTS - CHOOSE THE ZONING FOR THIS PROJECT AND COMPLETE ONLY THAT SECTION)

	<u>YES</u>	<u>NO</u>
1. C-1 Zoning - Neighborhood Commercial		
Lot area: minimum of 2,500 square feet; maximum 16,000 square feet	_____	_____
Front Yard: none required	_____	_____
Side Yard: minimum of 5 feet each side	_____	_____
Rear Yard: minimum of 55 feet	_____	_____
Maximum lot coverage of 70% of the total area of the site for all principal, accessory buildings, parking lots, sidewalks, private streets, or drives.	_____	_____
Parking: one space per each 200 sq. ft. of commercial use	_____	_____
Loading areas: physically separated from all streets with 10 ft grassy area	_____	_____
When abuts a residential district, a minimum 6' high wood, rock, or masonry fence is required with a landscape screen	_____	_____
2. C-2 Zoning - Lots fronting along roadways designated as Interstate 30 and frontage roads, State Highway 5 and 183		
Front Yard: not less than 50 feet from front property line	<u>X</u>	_____
Side Yard: not required, except where they abut a street or a residential lot line then a minimum of 25 feet is required	<u>X</u>	_____
Rear Yard: minimum of 15 feet, except where they abut residential area then a minimum of 55 feet is required	<u>X</u>	_____
A maximum lot coverage of 35% of the total area of the site for all principal and accessory buildings	<u>X</u>	_____
Parking: one space per each 300 sq. ft. of occupied space	<u>N/A</u>	_____
When abuts a residential district, a minimum 6' high wood, rock, or masonry fence is required with a landscape screen	<u>X</u>	_____
3. C-2 Zoning - Lots fronting along roadways designated as interior local.		
Front Yard: none required	_____	_____
Side Yard: not required, except where they abut a street or a residential lot line then a minimum of 25 percent of lot dimension	_____	_____
Rear Yard: minimum of 15 feet, except where they abut residential area then a minimum of 55 feet is required	_____	_____
A maximum lot coverage of 85% of the total area of the site for all principal, accessory buildings and parking	_____	_____
Parking: one space per each 300 sq. ft. of occupied space	_____	_____
When abuts a residential district, a minimum 6' high wood, rock, or masonry fence is required with a landscape screen	_____	_____

V. SITE PLAN ATTACHMENTS

(APPLICATION WILL NOT BE ACCEPTED UNTIL ALL ATTACHMENT REQUIREMENTS ARE MET)

- ▲ 26. Letter to Planning Commission stating your request
- ▲ 27. Completed Checklist
- ▲ 28. Completed ADA/ABA Form
- ▲ 29. Two full sets of Building Plans
- ▲ 30. 20 copies of Site Plan (folded to no larger than 8 1/2 X 14 size) that includes vicinity map and landscaping plan (minimum size 17" X 34" paper)
- ▲ 31. 20 copies of Landscaping Plan (folded to no larger than 8 1/2 X 14 size)
- ▲ 32. 20 copies of building floor plan (folded to no larger than 8 1/2 X 14 size)
- ▲ 33. Copy of Stormwater Detention approval
- ▲ 34. Copy of ADEQ Stormwater Pollution Prevention Plan for property containing one acre or larger.
- ▲ 35. IBM compatible diskette or CD with data in PDF format.
- ▲ 36. Receipt for \$250.00 for Stormwater Detention and Drainage Plan review

I CERTIFY that the design of ISBC Discipleship Addition in the City of Bryant, Arkansas complies with the above regulations, laws and codes.

<u>Indian Springs Baptist Church - Don Chancellor</u> Owner <u>23581 Interstate 30</u> Mailing Address <u>Bryant, AR 72022</u> City	<u>The Sentinel Group, LLC - Eric Krebs</u> Engineer/Architect <u>501-317-2547</u> Phone # <u>2-7-2018</u> Date
---	---

CITY USE

Action Taken:

Special Conditions:

Permit Issued: Date _____ Sq.Ft. _____ Amount \$ _____

Construction Completed Certified For Occupancy: Date: _____ Inspector: _____
--

Permit No. _____

BUILDING PERMIT

ADA/ABA ACCESSIBILITY STANDARDS

The *Americans with Disability Act* and *Architectural Barriers Act* Accessibility Guidelines were prepared by the U.S. Access Board and mandated by the U. S. Department of Justice regulations implementing Title III as the official ADA/ABA accessibility guidelines. **All new construction, remodeling, and modifications must conform to these building standards** for places of public accommodation and commercial facilities. Residential is exempt.

The ADA/ABA accessibility guidelines contain general design standards for building and site elements, such as accessible entrances and routes, ramps, parking spaces, stairs, elevators, restrooms, signage, etc. Also included are specific standards for restaurants, medical care facilities, libraries and transportation facilities and vehicles, and places of lodging.

The guidelines also include "scoping" requirements that outline the necessary features or appropriate quantity for achieving ready access. For example, at least 50 percent of all public entrances to buildings must be accessible with an accessible path of travel. In public restrooms, at least one bathroom stall must be accessible unless there are more than six stalls, in which case the number increases.

I hereby certify that I have read and examined the above notice and will comply with all guidelines of the ADA Accessibility Guidelines. I further understand that a copy of the ADA/ABA Regulations are available for inspection during business hours of City Hall or I may obtain a copy by writing:

The Access Board
1331 F Street, NW, Suite 1000
Washington, DC 20004-1111
(202) 272-0080 (v) (202) 272-0082 (TTY) (202) 272-0081 (fax)
(800) 872-2253 (v) (800) 993-2822 (TTY)
email: info@access-board.gov

Signature of Contractor
or Authorized Agent _____ Date _____

Signature of Owner
(if owner-builder) _____ Date _____

Application of Permit Approved: _____ Date _____
Commission - Chairman

Bryant Water & Sewer Department

GREASE TRAP STANDARDS

The City of Bryant requires all commercial buildings comply with plumbing codes found in the Arkansas State Plumbing Code, Latest Edition. All new construction, remodeling, and modifications must conform to these plumbing standards for places of public accommodation and commercial facilities. These guidelines contain general design standards for construction and site elements relating to plumbing.

As of 7/27/04, the Bryant Sewer & Water Commission requires stringent specification standards for commercial or public businesses that involve any food preparation on the premise. The new standard requires calculations, and associated data to be submitted to the Bryant Water Utilities General Manager concurrent with the proposed building plumbing plans along with a grease trap calculation form. Building Permits will not be issued until this form has been received and approved by the Bryant Water Utilities General Manager.

All new buildings or strip centers containing sections designated for commercial enterprise are encouraged to provide a stub-out for a separate waste line for future grease interceptor installation. The owner of a new strip center shall consider suitable physical property space and sewer gradient that will be conducive for the installation of an exterior, in-ground grease interceptor(s) for any flex space contained within the strip center. Physical Property Restrictions and sewer gradient shall not be a defense for failure to install an exterior, in-ground grease interceptor.

I hereby certify that I have read and examined the above notice and will comply with all guidelines of the City of Bryant Water & Sewer Department. I further understand that copies of the Grease Interceptor Design and Structural Criteria regulations will be available from the Bryant Water/Wastewater Plant (501-847-8083) during business hours.

Project Name _____

Signature of Contractor
or Authorized Agent _____ Date _____

Signature of Owner
(if owner-builder) _____ Date _____

Calculations
Approved: _____ Date _____
Bryant Water Utilities General Manager

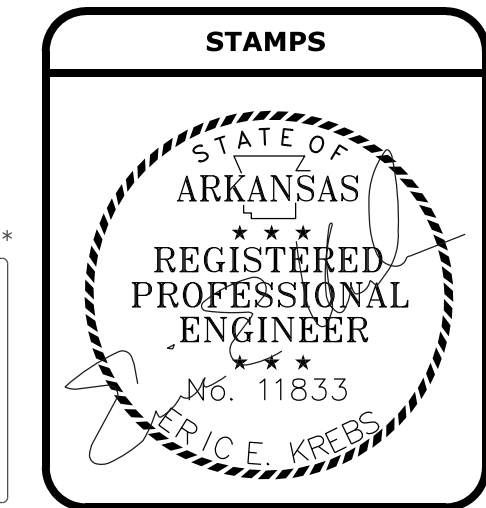
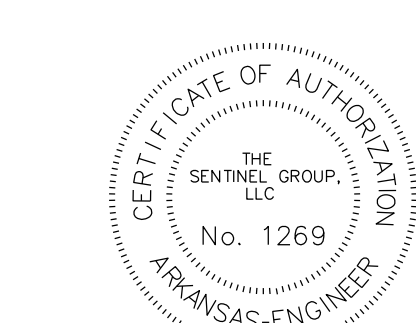
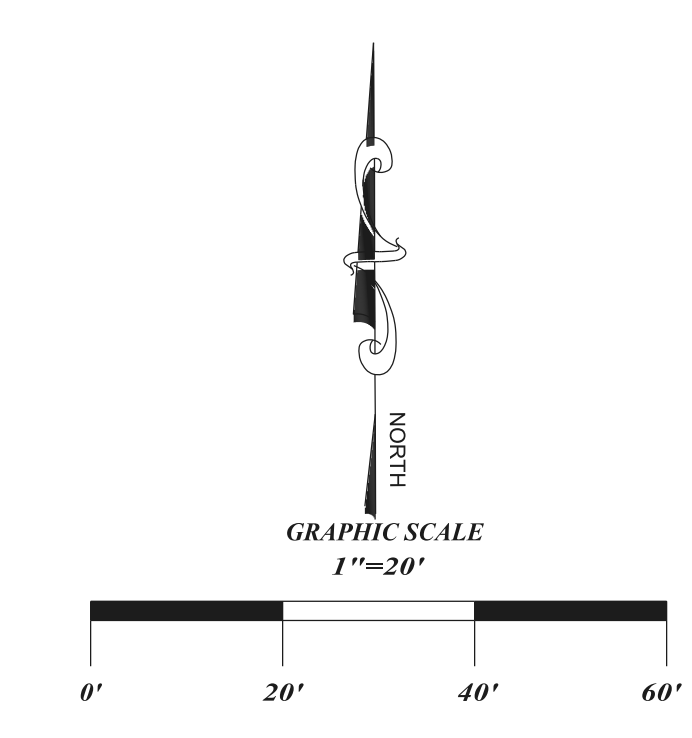
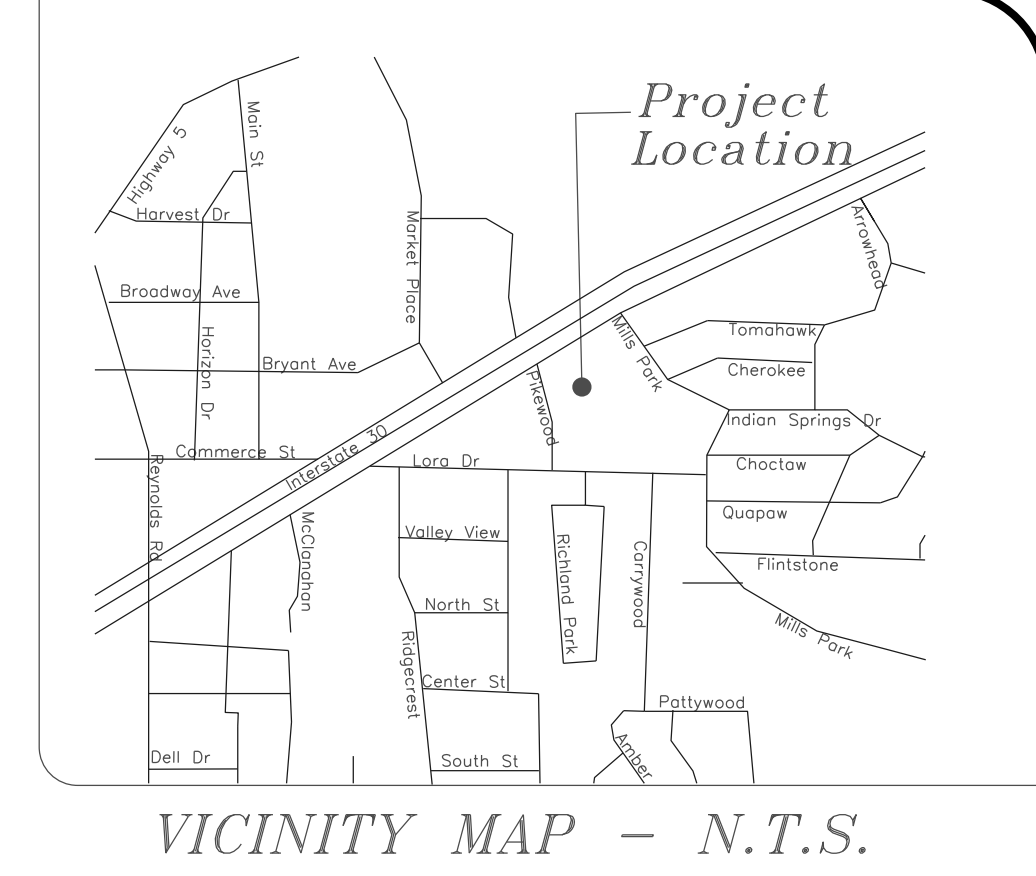

** UTILITY WARNING **

48 HOURS
BEFORE YOU DIG
CALL
ARKANSAS ONE CALL
(TOLL FREE)
1-800-482-9988
PRIOR TO CONSTRUCTION FOR
UNDERGROUND UTILITY LOCATION

<p>The Sentinel Group, LLC Civil Engineering - Development - Planning - Project Management 2712 Cypress Point Drive, Benton, Arkansas 72019 Ph: (501) 317-2547</p>		
<p>OWNER / DEVELOPER INDIAN SPRINGS BAPTIST CHURCH</p>		
<p>DEMOLITION PLAN BUILDING ADDITION INTERSTATE 30 BRYANT, ARKANSAS</p>		
DATE: 08/05/2016	C.A.D. BY: EEK	DRAWING NUMBER:
REVISIONS:	CHECKED BY: E. Krebs	C1
	SCALE: 1" = 20'	SHEET NUMBER:

SSMH

FFE
295.31

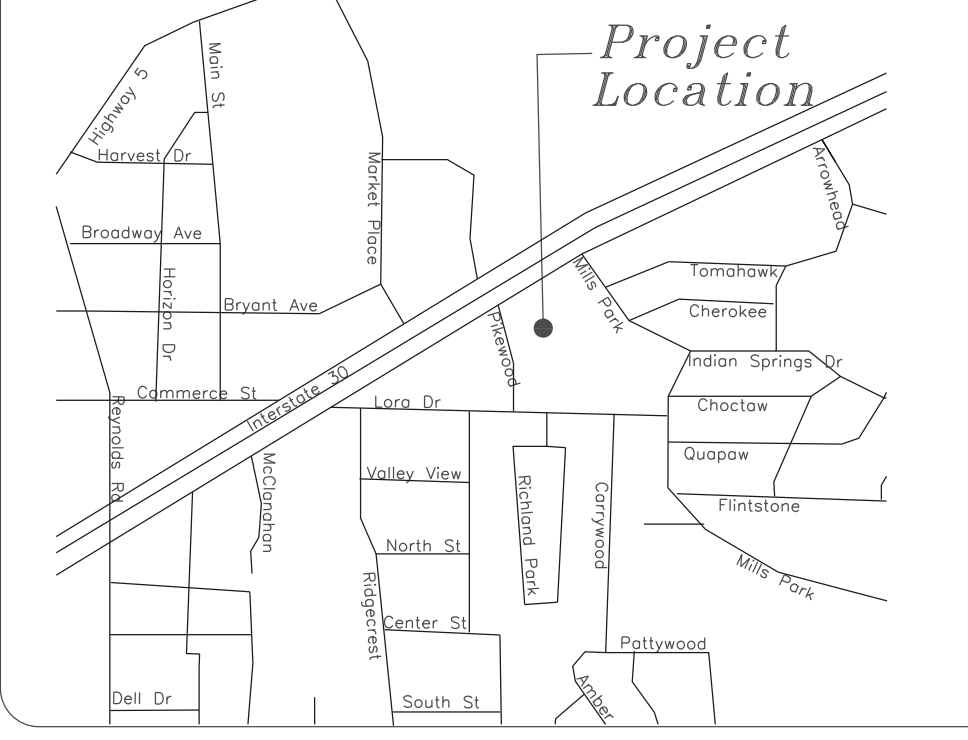
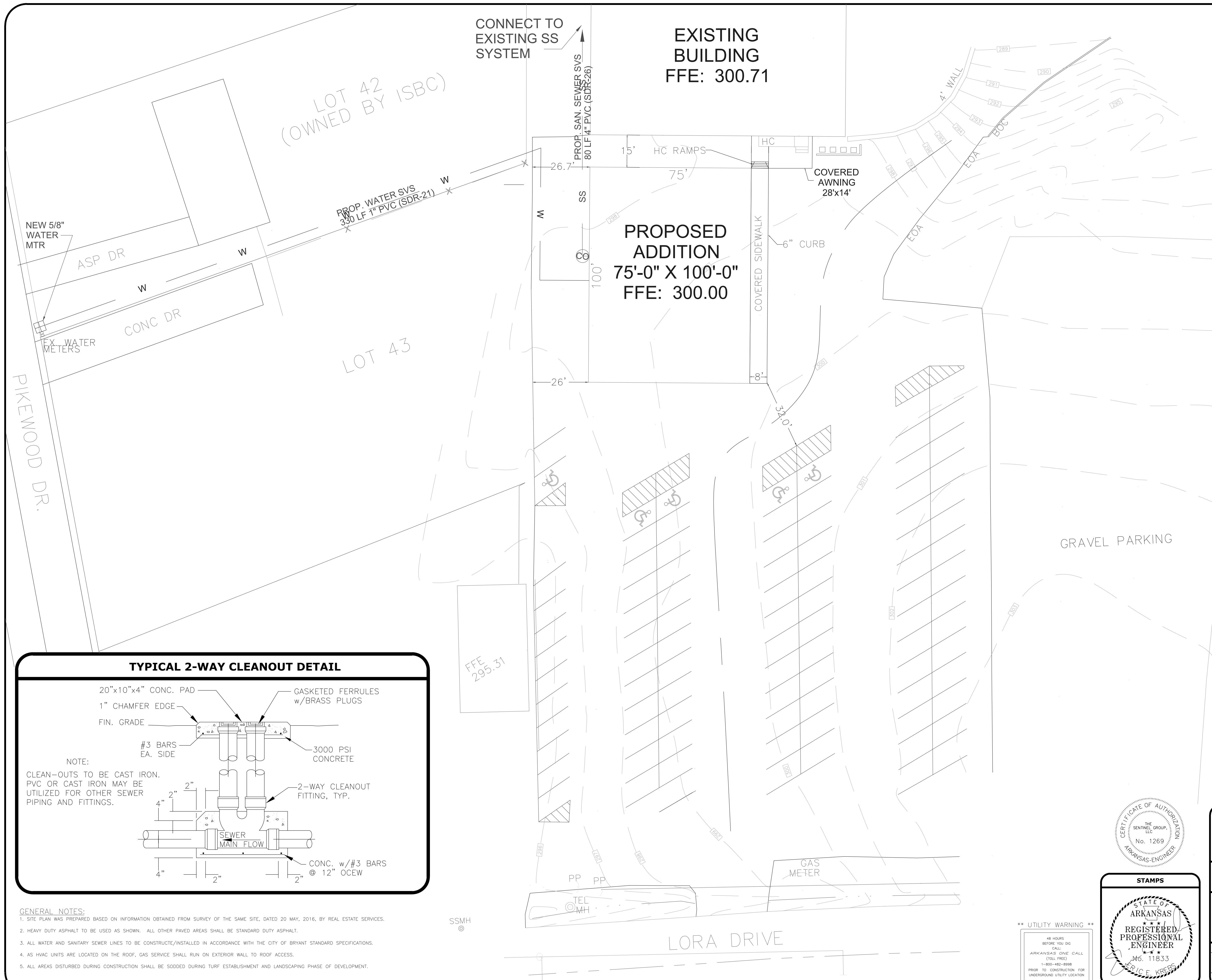

VICINITY MAP - N.T.S.

PROPERTY SPECIFICATIONS:

OWNER/DEVELOPER: INDIAN SPRINGS BAPTIST CHURCH
 23581 INTERSTATE 30
 BRYANT, AR 72022

ENGINEER: SENTINEL GROUP, LLC
 2712 CYPRESS POINT DR.
 BENTON, AR 72019

DISTURBED AREA: 21,773 SF/0.50 AC.
 IMPERVIOUS AREA: 21,773 SF
 PERVIOUS AREA: 21,773 SF
 ZONING: HIGHWAY COMMERCIAL (HCD)
 CURRENT USE: PARKING LOT
 PROPOSED USE: CHURCH ADDITION
 BUILDING SIZE: 7500 SF
 EASEMENTS: AS SHOWN

CONTRACTOR IS RESPONSIBLE FOR VERIFYING GRADE BEFORE AND DURING CONSTRUCTION

CONTRACTOR IS ALSO RESPONSIBLE FOR SHORING AND ENSURING THAT THERE IS NO SLOUGHING OF ADJACENT PROPERTY UNLESS OTHERWISE APPROVED IN WRITING BY THE ADJACENT PROPERTY OWNER.

UTILITY CONTACTS:

ELECTRIC:
 ENERGY
 BERNARD NEUMER
 9 ENERGY COURT
 LITTLE ROCK, AR 72211
 501-954-5158

WATER/SEWER:
 CITY OF BRYANT
 HOWARD HOOVER
 1019 S.W. 2ND ST.
 BRYANT, AR 72022
 501-943-0468

GAS:
 CENTERPOINT ENERGY
 ANDREW TOWNSEND
 401 W. CAPITOL SUITE 600
 LITTLE ROCK, AR 72201
 501-377-4679

TELEPHONE:
 ATT
 LYNDA PALMER
 1111 W. CAPITOL, RM. 941
 LITTLE ROCK, AR 72201
 501-373-5255

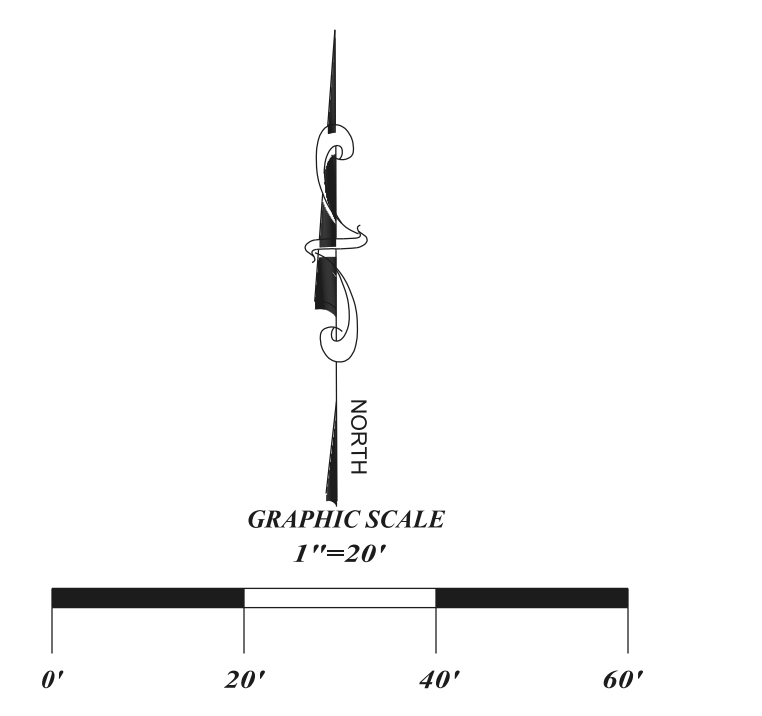

TYPICAL 2-WAY CLEANOUT DETAIL

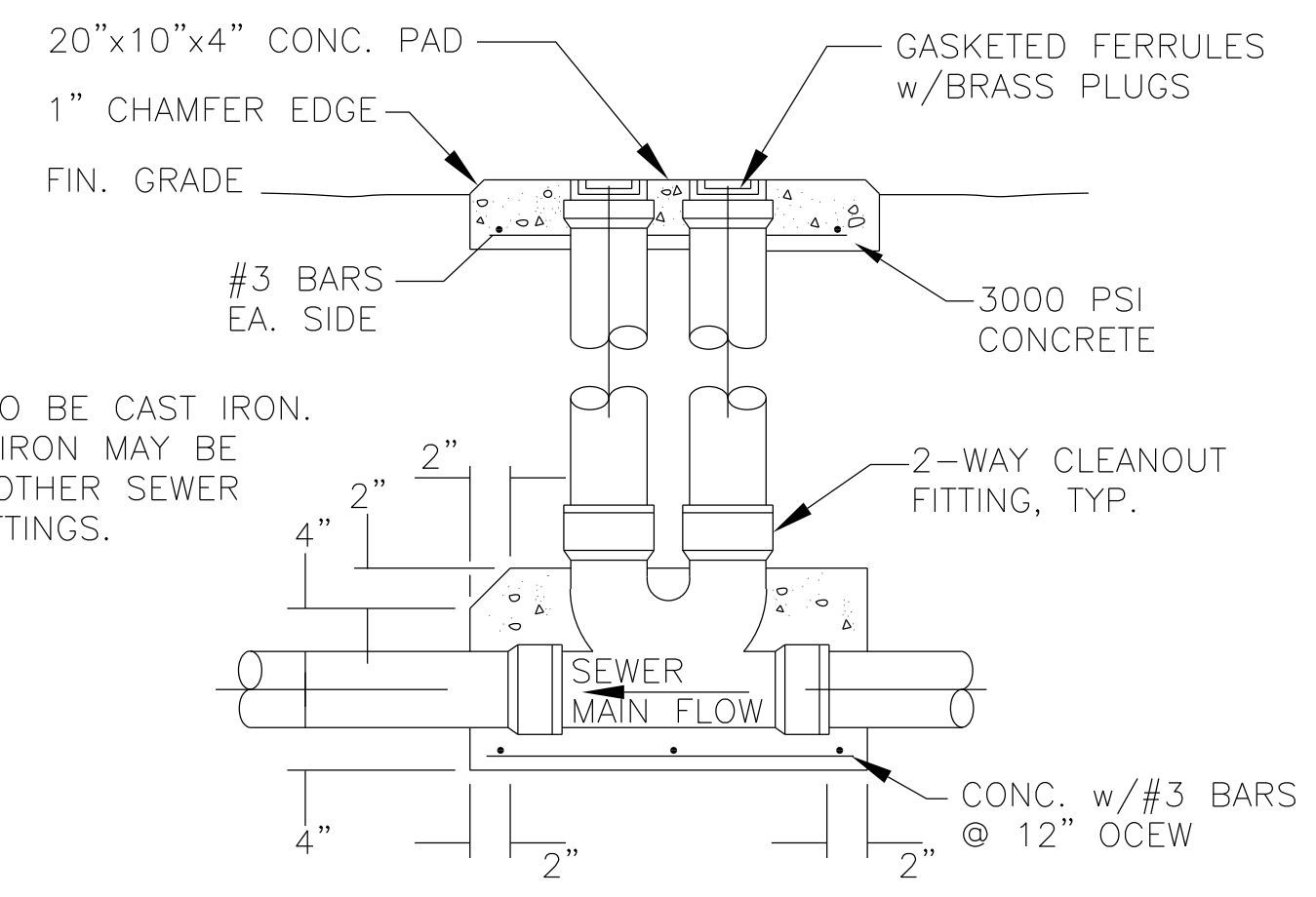

NOTE:
 CLEAN-OUTS TO BE CAST IRON.
 PVC OR CAST IRON MAY BE UTILIZED FOR OTHER SEWER PIPING AND FITTINGS.

- GENERAL NOTES:
1. SITE PLAN WAS PREPARED BASED ON INFORMATION OBTAINED FROM SURVEY OF THE SAME SITE, DATED 20 MAY, 2016, BY REAL ESTATE SERVICES.
 2. HEAVY DUTY ASPHALT TO BE USED AS SHOWN. ALL OTHER PAVED AREAS SHALL BE STANDARD DUTY ASPHALT.
 3. ALL WATER AND SANITARY SEWER LINES TO BE CONSTRUCTED/INSTALLED IN ACCORDANCE WITH THE CITY OF BRYANT STANDARD SPECIFICATIONS.
 4. AS HVAC UNITS ARE LOCATED ON THE ROOF, GAS SERVICE SHALL RUN ON EXTERIOR WALL TO ROOF ACCESS.
 5. ALL AREAS DISTURBED DURING CONSTRUCTION SHALL BE SODDED DURING TURF ESTABLISHMENT AND LANDSCAPING PHASE OF DEVELOPMENT.

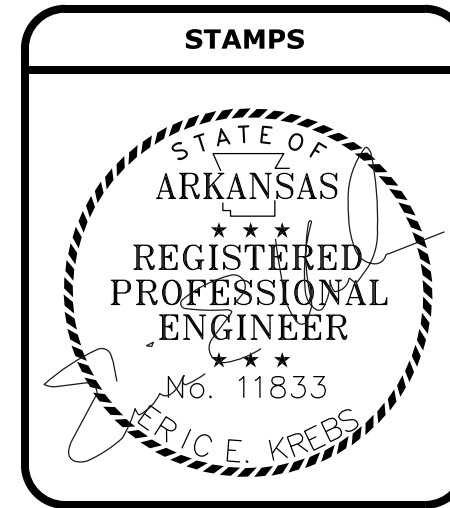

** UTILITY WARNING **

48 HOURS BEFORE YOU DIG CALL ARKANSAS ONE CALL (TOLL FREE) 1-800-482-8998 PRIOR TO CONSTRUCTION FOR UNDERGROUND UTILITY LOCATION

The Sentinel Group, LLC
 Civil Engineering - Development - Planning - Project Management
 2712 Cypress Point Drive, Benton, Arkansas 72019 Ph: (501) 317-2547

OWNER / DEVELOPER
INDIAN SPRINGS BAPTIST CHURCH

**SITE UTILITY/DIMENSION PLAN
 BUILDING ADDITION
 INTERSTATE 30
 BRYANT, ARKANSAS**

DATE: 08/05/2016	C.A.D. BY: EEK	DRAWING NUMBER:
REVISED:	CHECKED BY: E. Krebs	C2
	SCALE: 1" = 20'	SHEET NUMBER:

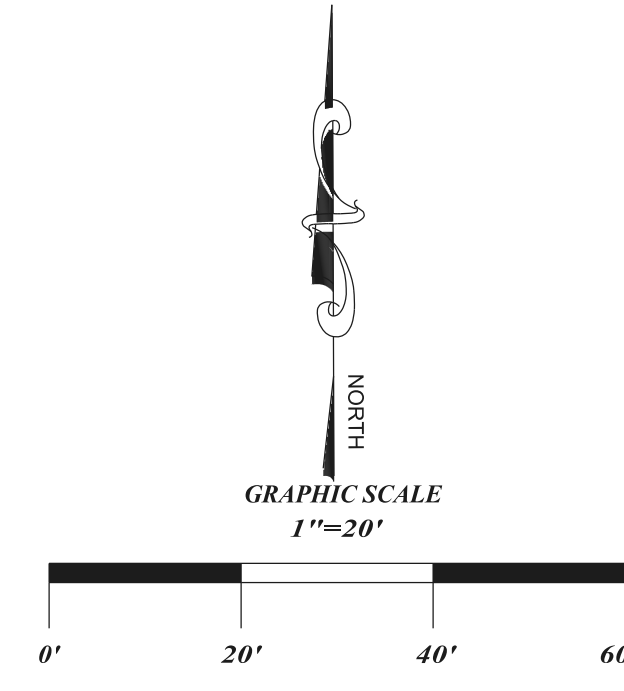

EXISTING BUILDING
FFE: 300.71

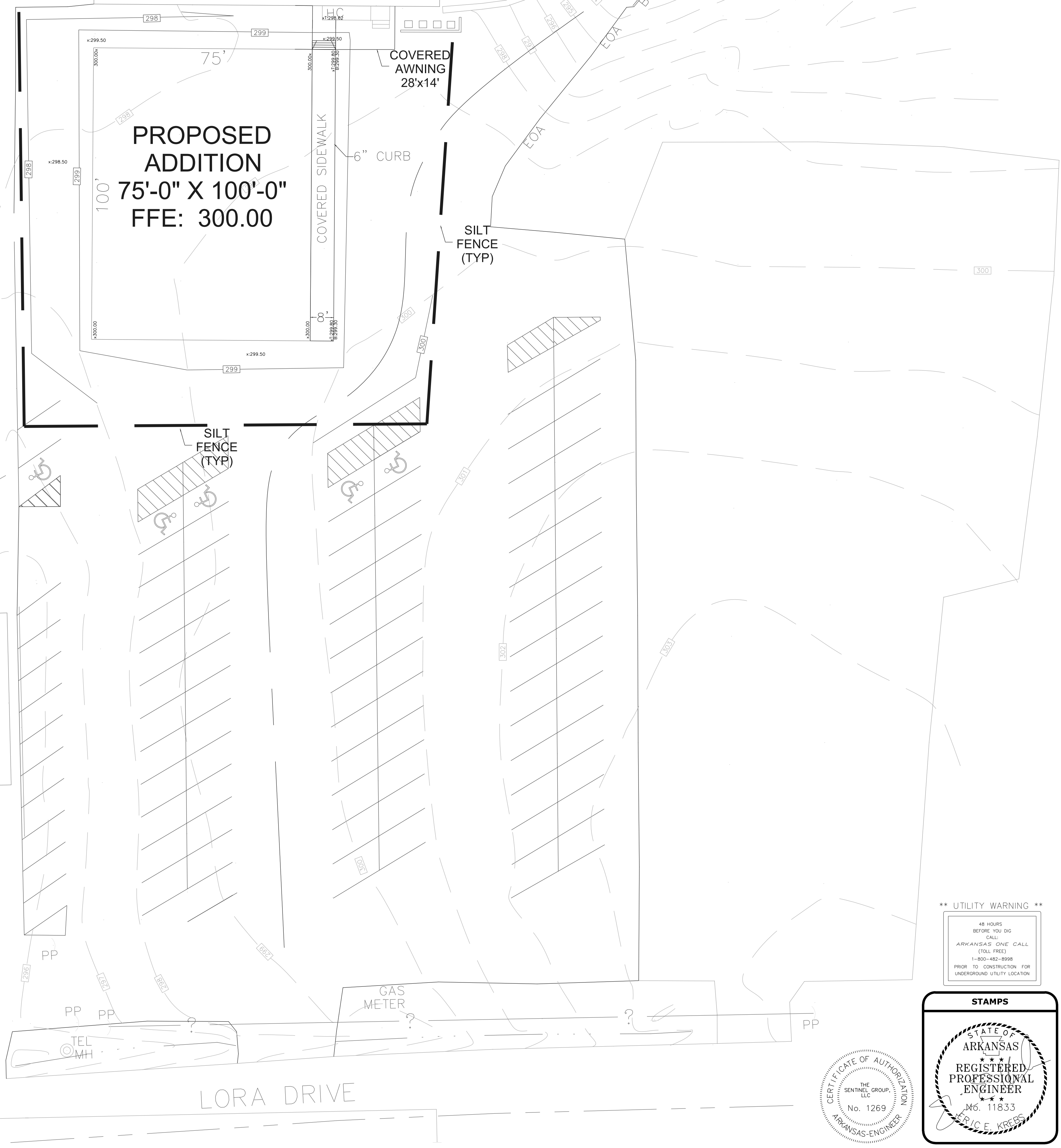
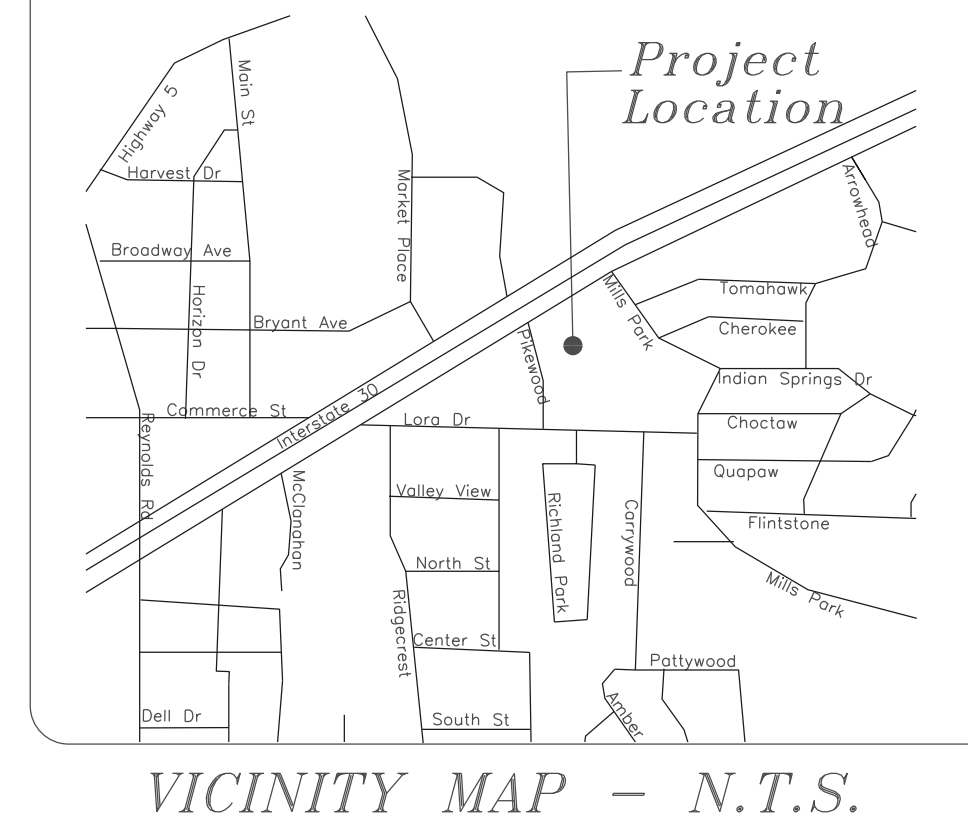

EROSION CONTROL DETAILS

WHAT IS THIS

A SILT FENCE ALSO CALLED A "FILTER FENCE" IS A TEMPORARY MEASURE FOR SEDIMENTATION CONTROL. IT USUALLY CONSISTS OF POSTS WITH FILTER FABRIC STRETCHED ACROSS THE POSTS AND SOMETIMES WITH A WIRE SUPPORT FENCE. THE LOWER EDGE OF THE FENCE IS VERTICALLY TRENCHED AND COVERED BY BACKFILL. A SILT FENCE IS USED IN SMALL DRAINAGE AREAS TO OBTAIN SEDIMENT. THESE FENCES ARE MOST EFFECTIVE WHERE THERE IS OVERLAND FLOW (RUNOFF THAT FLOWS OVER THE SURFACE OF THE GROUND AS A THIN, EVEN LAYER) OR IN MINOR SWALES OR DRAINAGEWAYS. THEY PREVENT SEDIMENT FROM ENTERING WATERS. SILT FENCES ARE ALSO USED TO CATCH WIND BLOW SAND AND TO CREATE AN ANCHOR FOR SAND DUNE CREATION, ASIDE FROM THE TRADITIONAL WOODEN POST AND FILTER METHOD. THERE ARE SEVERAL VARIATIONS OF SILT FENCE INSTALLATION INCLUDING SILT FENCE WHICH CAN BE PURCHASED WITH POCKETS WITH POCKETS PREWORN TO ACCEPT USE OF STEEL FENCE POSTS.

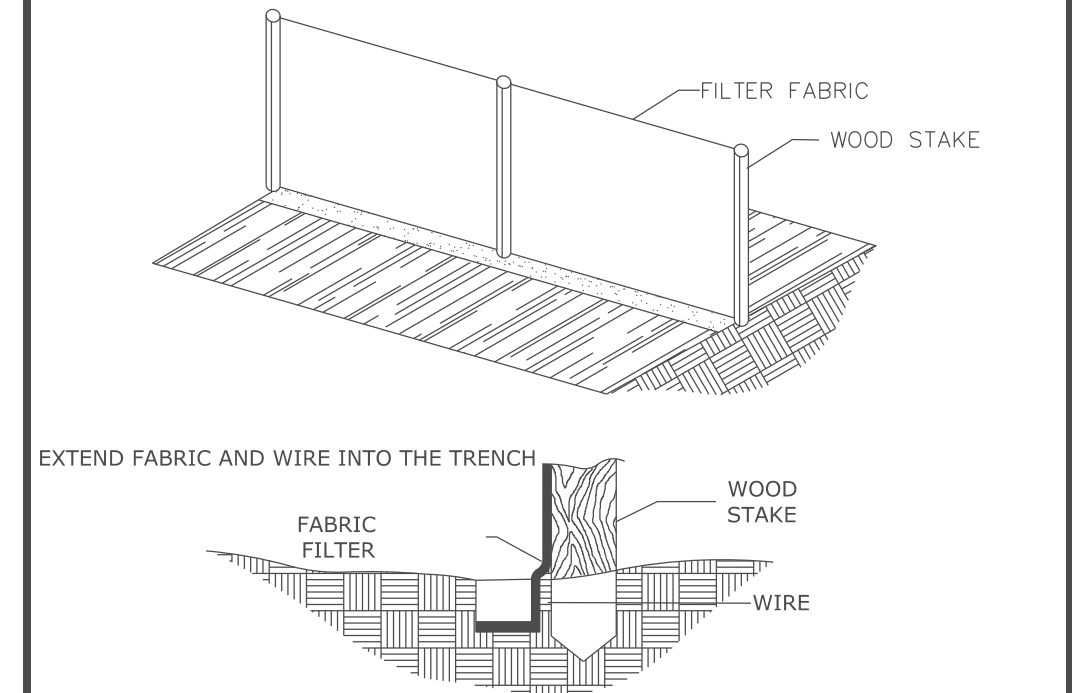

WHEN AND WHERE TO USE IT

AS SHOWN BY:

A SILT FENCE SHOULD BE INSTALLED PRIOR TO MAJOR SOIL DISTURBANCE IN THE DRAINAGE AREA. SUCH A STRUCTURE IS ONLY APPROPRIATE FOR DRAINAGE AREAS OF 1 ACRE OR LESS WITH VELOCITIES OF 0.5 CFS OR LESS (WASHINGTON STATE, 1992). THE FENCE SHOULD BE PLACED ACROSS THE BOTTOM OF A SLOPE OR MINOR DRAINAGEWAY ALONG A LINE OF UNIFORM ELEVATION (PERPENDICULAR TO THE DIRECTION OF FLOW). IT CAN BE USED AT THE OUTER BOUNDARY OF THE WORK AREA. HOWEVER, THE FENCE DOES NOT HAVE TO SURROUND THE WORK AREA COMPLETELY. IN ADDITION, A SILT FENCE IS EFFECTIVE WHERE SHEET AND HILL EROSION MAY BE A PROBLEM. SILT FENCES SHOULD NOT BE CONSTRUCTED IN STREAMS OR SWALES.

STRAW BALE BARRIER

WHAT IS THIS

STRAW BALES CAN BE USED AS A TEMPORARY SEDIMENT BARRIER. THEY ARE PLACED END TO END IN A SHALLOW EXCAVATED TRENCH (WITH NO GAPS IN BETWEEN) AND STAKED INTO PLACE. IF PROPERLY INSTALLED, THEY CAN DETAIN SEDIMENT AND REDUCE FLOW VELOCITY FROM SMALL DRAINAGE AREAS. A STRAW BALE BARRIER PREVENTS SEDIMENT FROM LEAVING THE SITE BY TRAPPING THE SEDIMENT IN THE BARRIER WHILE ALLOWING THE RUNOFF TO PASS THROUGH. IT CAN BE USED TO DECREASE THE VELOCITY OF SHEETFLOW OR CHANNEL FLOWS OF LOW-TO-MODERATE LEVELS.

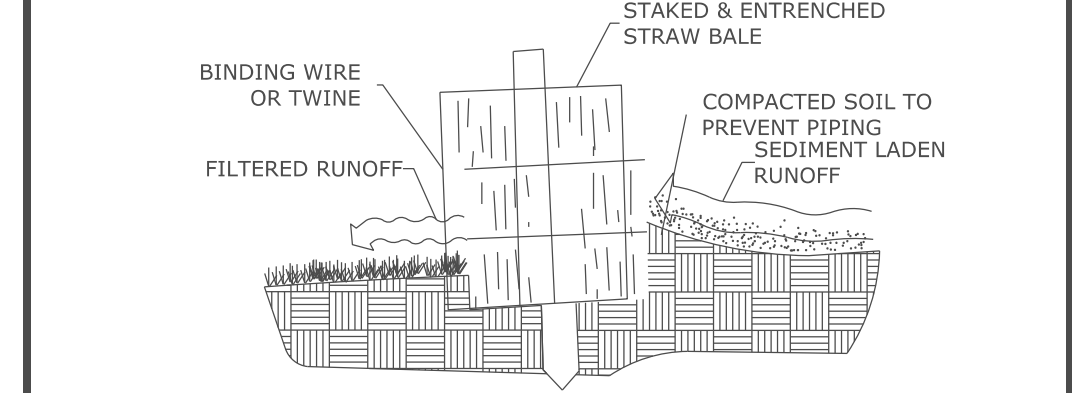

CROSS SECTION OF A PROPERLY INSTALLED STRAW BALE BARRIER

WHEN AND WHERE TO USE IT

AS SHOWN BY:

A STRAW BALE BARRIER SHOULD BE INSTALLED PRIOR TO MAJOR SOIL DISTURBANCE IN THE DRAINAGE AREA. THIS TYPE OF BARRIER IS PLACED PERPENDICULAR TO THE FLOW, ACROSS THE BOTTOM OF A SLOPE OR MINOR DRAINAGEWAY WHERE THERE IS SHEET FLOW. IT CAN BE USED AT THE PERIMETER OF THE WORK AREA. ALTHOUGH IT DOES NOT HAVE TO SURROUND IT COMPLETELY, IT CAN ALSO BE VERY EFFECTIVE WHEN USED IN COMBINATION WITH OTHER EROSION AND SEDIMENT CONTROL PRACTICES. A STRAW BALE BARRIER MAY BE USED WHERE THE LENGTH OF SLOPE BEHIND THE BARRIER IS LESS THAN 100 FEET AND WHERE THE SLOPE IS LESS THAN 2:1.

WHAT TO CONSIDER

THE SUCCESS OF A STRAW BALE BARRIER DEPENDS ON PROPER INSTALLATION. THE BALES MUST BE FIRMLY STAKED INTO THE ENTRENCHMENT AND THE ENTRENCHMENT MUST BE PROPERLY BACKFILLED. TO FUNCTION EFFECTIVELY, THE BALES MUST BE PLACED END TO END AND THERE CAN BE NO GAPS BETWEEN THE BALES.

STRAW BALE BARRIERS ARE USEFUL FOR APPROXIMATELY 3 MONTHS. THEY MUST BE INSPECTED AND REPAIRED IMMEDIATELY AFTER EACH RAINFALL. ONLY IF THERE IS PROLONGED RAINFALL, DAMAGED STRAW BALES REQUIRE DAMAGED STRAW BALES REQUIRE IMMEDIATE REPLACEMENT. AFTER EACH STORM, OR ON A REGULAR BASIS, TRAPPED SEDIMENTS MUST BE REMOVED AND DISPOSED OF PROPERLY.

- EROSION CONTROL NOTES**
1. The site must be posted as required by the NPDES Permit, to include the NPDES Notice of Intent, Permit Number, and this plan.
 2. All stormwater pollution control measures must be inspected every 7 days.
 3. A rain gauge is required to be installed somewhere on site. If the gauge indicates 1/2" or more of rainfall within a 24 hr. period, an inspection of all control measures must be accomplished immediately.
 4. Hay bales will be installed at all storm inlets to reduce silt and sediment entering the receiving stream.
 5. Records must be maintained for all inspections conducted. All control measures must be maintained to adequately filter silt and debris that may exit the site by storm water runoff.
 6. A silt fence barrier is to be placed 70' on each side of the centerline of right of way at the time of road construction.
 7. All sedimentation basins will be used for erosion control purposes.

REVISION BLOCK

NO.	DESCRIPTION	DATE

- EROSION CONTROL NOTES**
1. The site must be posted as required by the NPDES Permit, to include the NPDES Notice of Intent, Permit Number, and this plan.
 2. All stormwater pollution control measures must be inspected every 7 days.
 3. A rain gauge is required to be installed somewhere on site. If the gauge indicates 1/2" or more of rainfall within a 24 hr. period, an inspection of all control measures must be accomplished immediately.
 4. Hay bales will be installed at all storm inlets to reduce silt and sediment entering the receiving stream.
 5. Records must be maintained for all inspections conducted. All control measures must be maintained to adequately filter silt and debris that may exit the site by storm water runoff.
 6. A silt fence barrier is to be placed 70' on each side of the centerline of right of way at the time of road construction.
 7. All sedimentation basins will be used for erosion control purposes.

CONTRACTOR IS RESPONSIBLE FOR VERIFYING GRADE BEFORE AND DURING CONSTRUCTION

CONTRACTOR IS ALSO RESPONSIBLE FOR SHORING AND ENSURING THAT THERE IS NO SLOUGHING OF ADJACENT PROPERTY UNLESS OTHERWISE APPROVED IN WRITING BY THE ADJACENT PROPERTY OWNER.

**** UTILITY WARNING ****

48 HOURS BEFORE YOU DIG
CALL
ARKANSAS ONE CALL
(TOLL FREE)
1-800-482-8998
PRIOR TO CONSTRUCTION FOR UNDERGROUND UTILITY LOCATION

STAMPS

STATE OF ARKANSAS
REGISTERED PROFESSIONAL ENGINEER
No. 11833
ERIC E. KREBS

CERTIFICATE OF AUTHORIZATION
THE SENTINEL GROUP LLC
No. 1269
ARKANSAS-ENGINEER

The Sentinel Group, LLC
Civil Engineering - Development - Planning - Project Management
2712 Cypress Point Drive, Benton, Arkansas 72019 Ph: (501) 317-2547

OWNER / DEVELOPER
INDIAN SPRINGS BAPTIST CHURCH

**GRADING PLAN
BUILDING ADDITION
INTERSTATE 30
BRYANT, ARKANSAS**

DATE: 08/05/2016	C.A.D. BY: EEK	DRAWING NUMBER:
REVISIONS:	CHECKED BY: E. Krebs	C3
	SCALE: 1" = 20'	SHEET NUMBER:

THIS DRAWING IS FOR PRICING AND PRESENTATION PURPOSES ONLY AND WAS NOT DESIGNED BY AN LICENSED ARCHITECT IN THE STATE OF ARKANSAS

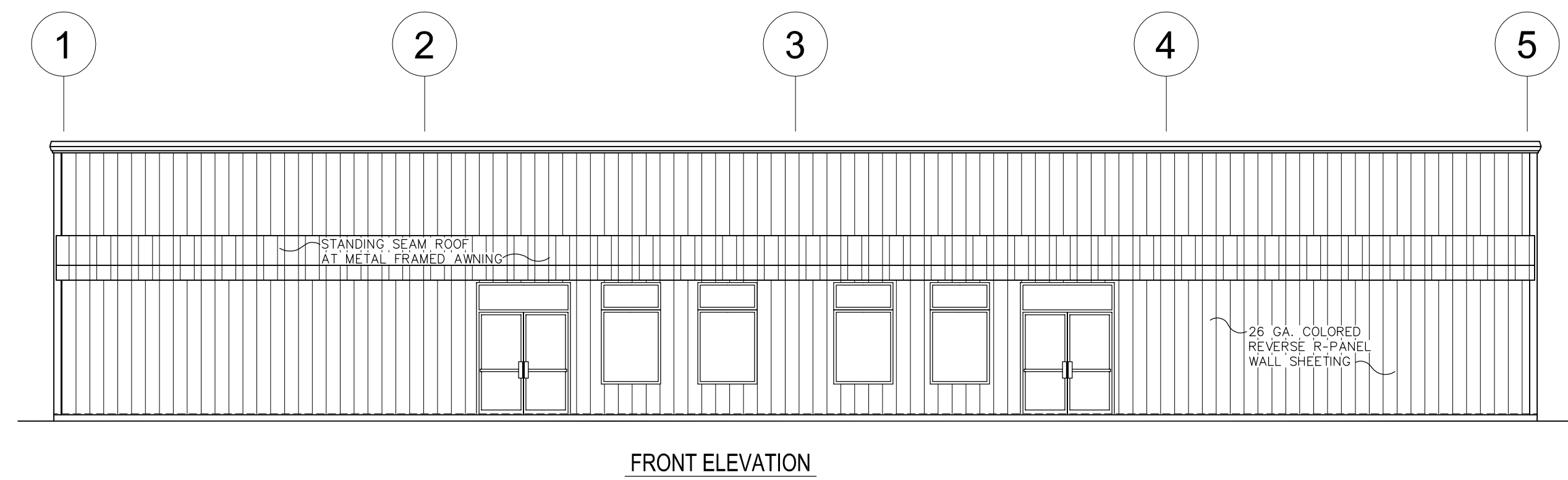
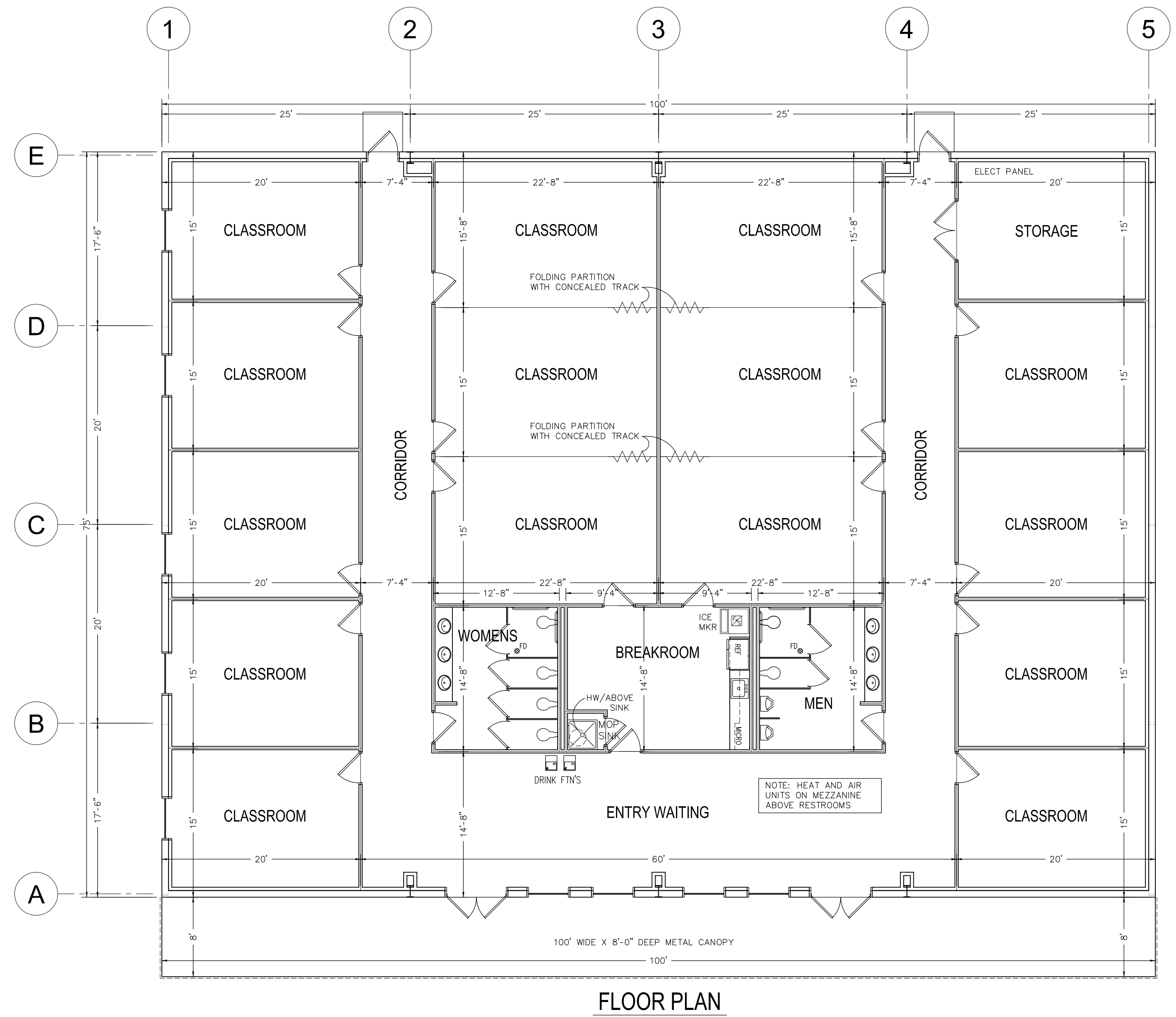
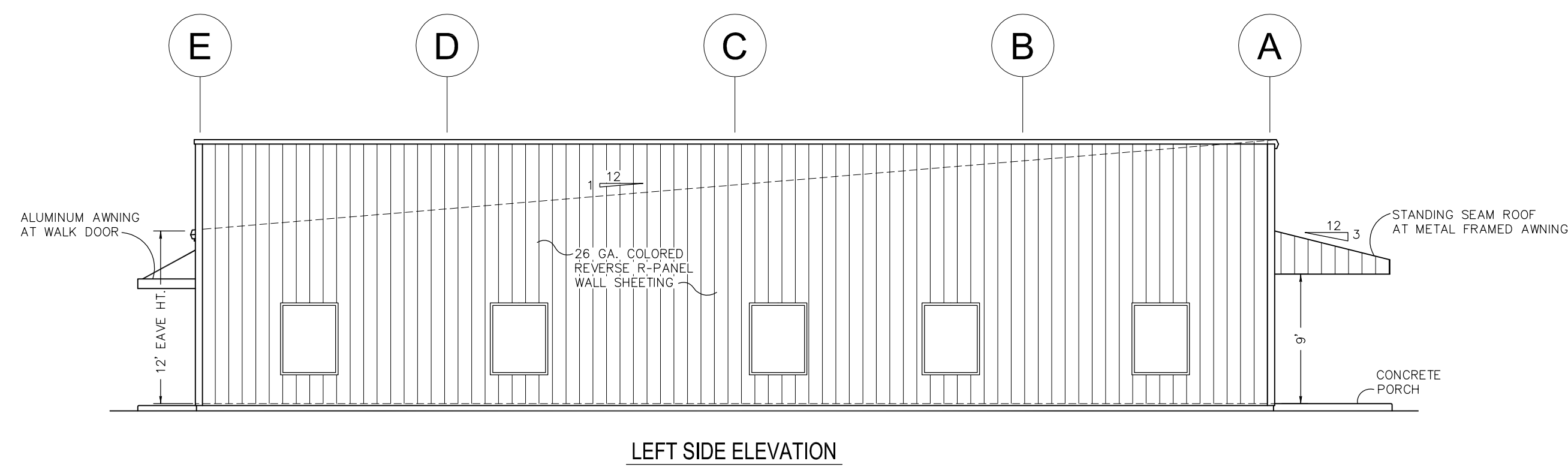
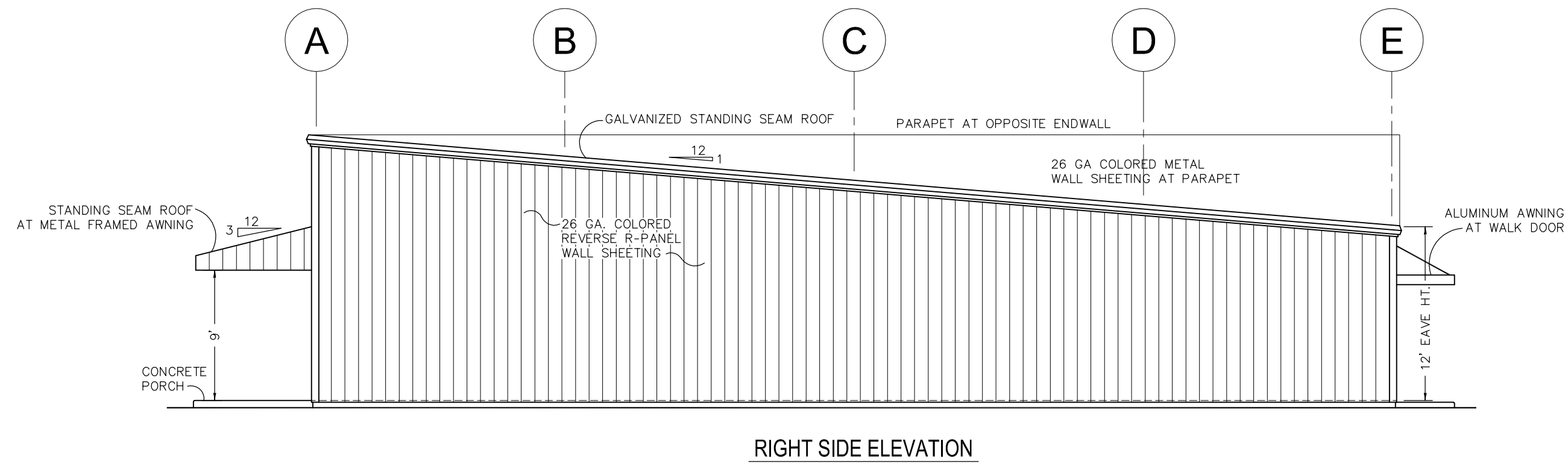
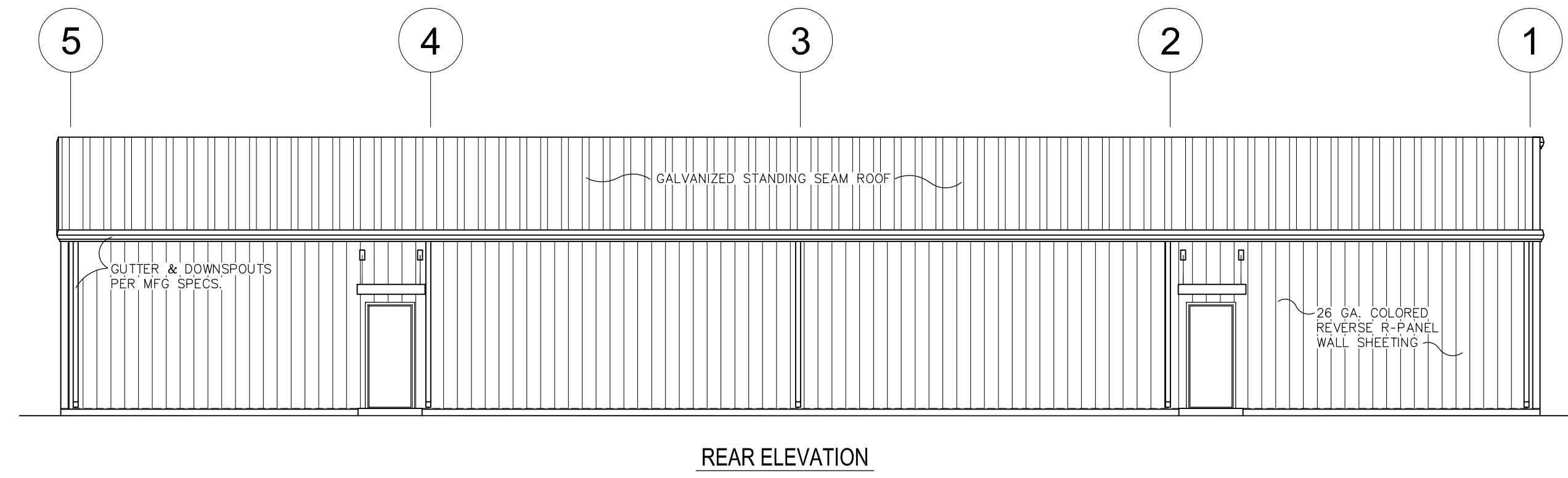

REV	DATE	DESCRIPTION

AMB General Contractors
 3501 Hwy 161
 North Little Rock, Arkansas

Indian Springs Baptist Church
 23581 Interstate 30 South
 Bryant, Arkansas

Date: 3-9-2017
 Sheet Title: FLOOR PLAN ELEVATIONS
 of
 Sheet No: A-1.1



Remove This section & repave

Take in one parking space for sign

Relocated Sign Location

Existing Sign Location

City of Bryant, Arkansas
Code Enforcement, Permits and Inspections
312 Roya Lane
Bryant, Ar 72022
501-943-0943

SIGN PERMIT APPLICATION

Applicants are advised to read the sign ordinance prior to completing and signing this form. The Sign Ordinance is available at www.cityofbryant.com

Site plan showing placement of sign and any existing signs on the property. A rendering of sign showing correct dimensions of all signs are required with application. Additional documentation may be required by Sign Administrator.

Date: February 6, 2018

Note: Electrical permits may be Required, Please contact the Permits Office at 501-943-0943 for more information.

**SIGN CO. OR
SIGN OWNER**

Name Cuerden Sign Co., Inc.
Address PO Box 187

City, State, Zip Conway AR 72033

Phone 5013296317

Alternate Phone 501 472 8884 cell

PROPERTY OWNER

Name Relyance Bank
Address 4937 AR-5

City, State, Zip Bryant AR 72022

Phone 501 847 7982

Alternate Phone 870-540-1246

GENERAL DETAILS

Name of Business Relyance Bank

Address/Location of sign 4937 AR-5, Bryant AR

Sign dimensions (height, length, width) 4'x10'
7'6"x12' incl pole covers

Zoning Classification _____

Height of sign from lot surface: Bottom 6"

SIGN TYPE

Pole Monument

Wall

Other (type) _____

Total sq. ft. _____

Aggregate Surface Area (total all signs) 168

Top 8'

READ CAREFULLY BEFORE SIGNING

I Jasper Burton Jr., do hereby certify that all information contained within this application is true and correct. I fully understand that the terms of the Sign Ordinance supersede the Sign Administrator's approval and that all signs must fully comply with all terms of the Sign Ordinance regardless of approval. I further certify that the proposed sign is authorized by the owner of the property and that I am authorized by the property owner to make this application. I understand that no sign may be placed in any public right of way. I understand that I must comply with all Building and Electrical Codes and that it is my responsibility to obtain all necessary permits.

Applicant's Signature 

Date 2/6/18

Sign Administrator(or Designee) Approval _____ Date _____

City of Bryant, Arkansas
Code Enforcement, Permits and Inspections
312 Roya Lane
Bryant, Ar 72022
501-943-0943

SIGN PERMIT APPLICATION

Applicants are advised to read the sign ordinance prior to completing and signing this form. The Sign Ordinance is available at www.cityofbryant.com

Site plan showing placement of sign and any existing signs on the property. A rendering of sign showing correct dimensions of all signs are required with application. Additional documentation may be required by Sign Administrator.

Date: February 6, 2018

Note: Electrical permits may be Required, Please contact the Permits Office at 501-943-0943 for more information.

**SIGN CO. OR
SIGN OWNER**

Name Cuerden Sign Co., Inc.
Address PO Box 187

City, State, Zip Conway AR 72033

Phone 5013296317

Alternate Phone 501 472 8884 cell

PROPERTY OWNER

Name Relyance Bank
Address 4937 AR-5

City, State, Zip Bryant AR 72022

Phone 501 847 7982

Alternate Phone 870-540-1246

GENERAL DETAILS

Name of Business Relyance Bank

Address/Location of sign 4937 AR-5, Bryant AR

Sign dimensions (height, length, width) 4x24

Zoning Classification _____ Aggregate Surface Area (total all signs) 168

Height of sign from lot surface: Bottom 6" Top 8'

SIGN TYPE

____ Pole Monument

Wall

____ Other (type) _____

Total sq. ft. 96

READ CAREFULLY BEFORE SIGNING

I Jasper Burton Jr., do hereby certify that all information contained within this application is true and correct. I fully understand that the terms of the Sign Ordinance supersede the Sign Administrator's approval and that all signs must fully comply with all terms of the Sign Ordinance regardless of approval. I further certify that the proposed sign is authorized by the owner of the property and that I am authorized by the property owner to make this application. I understand that no sign may be placed in any public right of way. I understand that I must comply with all Building and Electrical Codes and that it is my responsibility to obtain all necessary permits.

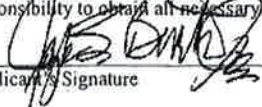
Applicant's Signature

2/6/18
Date

Sign Administrator(or Designee) Approval

Date

non illuminated logo
to cover stained glass

3'-6"

Lighted channel letters

4'-0"

Relyance Bank



23'-10 3/4"

Approved by _____
Date _____
Drawn By: jb
Scale 1/4" = 1'
Note: Colors may not reproduce
exactly due to ink/pigment differences

This design is the property of:



Serving Arkansas Since 1920

PO Box 187
Conway AR 72032-0187
www.ccsigns.com email: cuerden@swbell.net
(501) 329-6317 Fax (501) 327-3438 (800) 844-3155
Copyright protected artwork

City of Bryant, Arkansas
Code Enforcement, Permits and Inspections
312 Roya Lane
Bryant, Ar 72022
501-943-0943

SIGN PERMIT APPLICATION

Applicants are advised to read the sign ordinance prior to completing and signing this form. The Sign Ordinance is available at www.cityofbryant.com

Site plan showing placement of sign and any existing signs on the property. A rendering of sign showing correct dimensions of all signs are required with application. Additional documentation may be required by Sign Administrator.

Date: 2/23/2018

Note: Electrical permits may be Required, Please contact the Permits Office at 501-943-0943 for more information.

SIGN CO. OR
SIGN OWNER
Name Scott Irvin
Address 5313 Hwy 204 woodland DR
City, State, Zip Redfield, AR, 72132
Phone 870-692-5992
Alternate Phone _____

PROPERTY OWNER
Name John Rees
Address 11719 Hinson Rd Ste 130
City, State, Zip Little Rock, AR, 72212
Phone 501-223-9298
Alternate Phone _____

GENERAL DETAILS
Name of Business Freedom Ink

SIGN TYPE
 Pole Monument

Address/Location of sign 5313 Hwy 5 north

Wall
 Other (type) _____

Sign dimensions (height, length, width) 2' x 11'

Total sq. ft. 22

Zoning Classification _____ Aggregate Surface Area (total all signs) 22'

Height of sign from lot surface: Bottom 15' Top 17'

READ CAREFULLY BEFORE SIGNING

I, Scott Irvin, do hereby certify that all information contained within this application is true and correct. I fully understand that the terms of the Sign Ordinance supersede the Sign Administrator's approval and that all signs must fully comply with all terms of the Sign Ordinance regardless of approval. I further certify that the proposed sign is authorized by the owner of the property and that I am authorized by the property owner to make this application. I understand that no sign may be placed in any public right of way. I understand that I must comply with all Building and Electrical Codes and that it is my responsibility to obtain all necessary permits.

Scott Irvin
Applicant's Signature

2/23/18
Date

Sign Administrator (or Designee) Approval Date

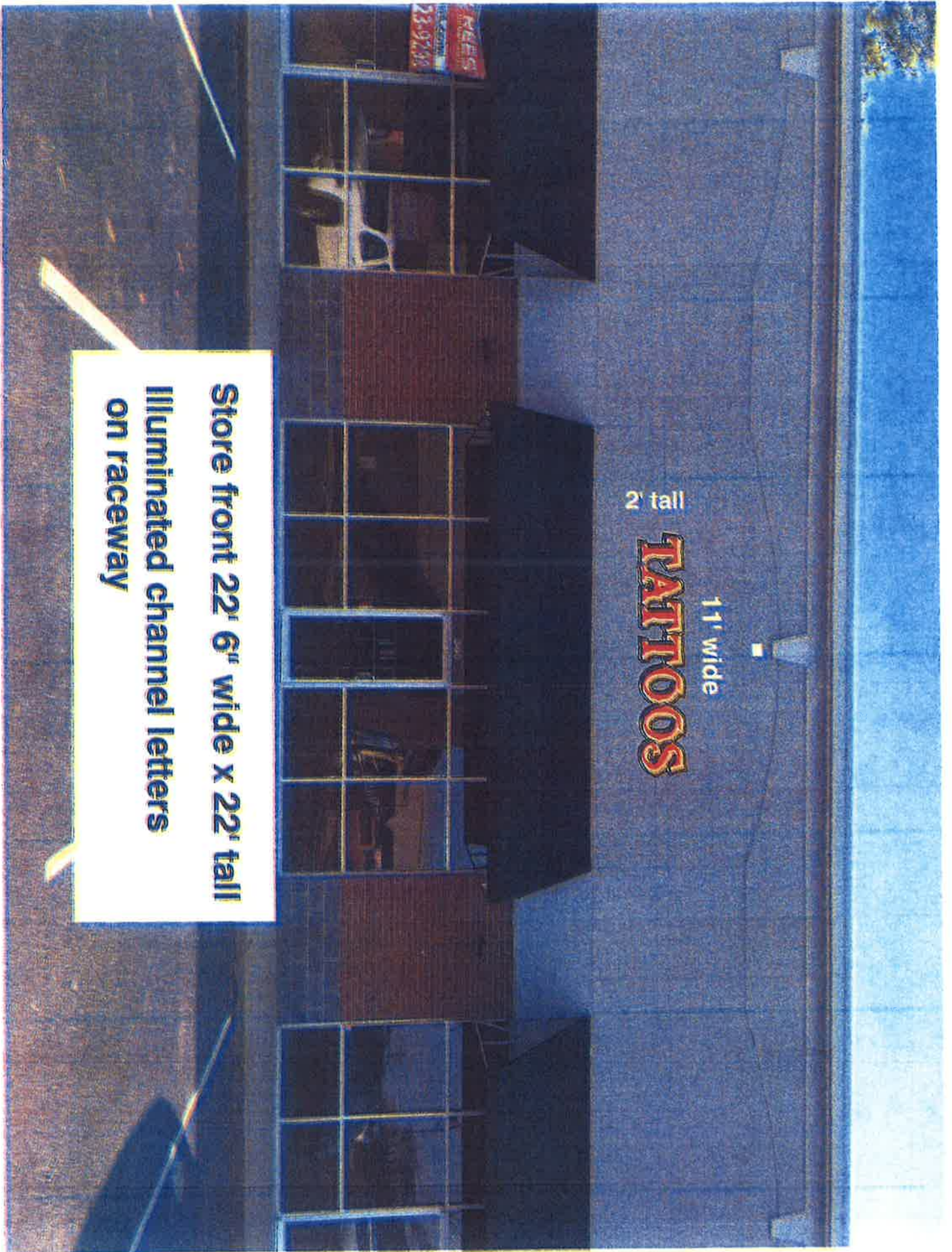

2' tall

TATTOOS

11' wide

**Store front 22' 6" wide x 22' tall
Illuminated channel letters
on raceway**

2' tall

LAITIOS

11' wide

February 8, 2018

City of Bryant

To Whom It May Concern,

Please find enclosed our notification, request, permit application to take an existing sign location and convert one of the two panels to a EMD , digital format.

The existing location is at 23277 Interstate 30. I have included pictures. Our landowner is Jeff Holder , he leases his lot to Lamar for the existing billboard sign and to Quality Auto of Bryant.

Lamar is requesting to convert the left hand read , east bound face for west bound traffic to a 12 x 25 EMD, digital face and the right hand read , west face of east bound traffic would remain a static 10'6" x 36' as it is currently. The pole placement would remain as is currently.

This is a reduction in the currently permitted size of face. I also have pictures, signatures from all parties and copy of city permit for existing sign.

I have included application and will accompany this letter with it for explanation. Please let me know if additional is needed.

Thank you,



Greg Criner
Real Estate Manager

OFF-PREMISE SIGN PERMIT APPLICATION REQUIREMENTS & REGULATIONS

Before any permit is granted for the erection of a sign or sign structure, plans and specifications shall be filed with the City of Bryant Planning Commission showing:

- ❖ The dimensions of the sign
- ❖ The dimensions of the sign's supporting members
- ❖ The maximum height of the sign
- ❖ If a freestanding sign, a plot plan showing setbacks from all property lines, buildings, and driveways is required to be submitted. All sight triangles are required to be shown on the plot plan.
- ❖ The materials, finish, and details of construction including loads, stresses, anchorage and any other pertinent engineering data
- ❖ The application for a permit shall be accompanied by the written consent of the owner or lessee of the premises upon which the sign is to be erected for city officials to enter said premises to inspect such sign
- ❖ The application for a permit shall be accompanied by all applicable fees. (If the application cannot be approved the permit fee and explanation of the problem will be returned.)

BILLBOARD PERMIT APPLICATION

CITY OF BRYANT

312 ROYA LN

Bryant, AR 72022

(501) 943-0943 ext. 3

Date 2/3/18

Permit _____

Note: This application must be completely filled out to obtain a permit.

PLEASE PRINT:

Location or address of construction site: 23277 1-30

Owner of Premises: Self Holder

Tenant: Car lot of Quality Auto of Bryant

Sign Contractor: Home Advertisement - Conversion

of existing location to

FREE STANDING, GROUND, POST OR PYLON SIGN

- Size of sign: Outside dimension (greatest height by greatest length exclusive of any supporting structure which is not illuminated, not in the form of a symbol and contains no advertising copy) _____ feet high x _____ feet long = _____ square feet
- Frontage on road _____ feet
- Distance of bottom of sign above the road centerline is _____ feet
- Distance of top of sign from ground level is _____ feet
- Distance of sign from edge of improved road or curb _____ feet
- Distance of sign from legal right of way _____ feet
- Distance of sign from side of nearest street or driveway is _____ feet
- Distance of sign from side property line _____ feet & _____ feet
- Distance of sign from front property line _____ feet
- Distance of sign from the rear property line _____ feet

EMO Digital

ESTIMATED COST (include construction of new sign and all labor and materials going into proposed work on the site) \$ _____

OPERATION OF SIGN (CHECK ONE)

- Is the sign electrical? YES NO EXISTING ELECTRIC
- Will the sign be (please check all that apply):
 - Billboard (commercial outdoor advertisement)
 - Directly Illuminated Red or Green Lights
 - Indirectly Illuminated Flash Interrupted Current
 - Rotate or Move in any Manner

ARE YOU REMOVING THE EXISTING SIGN CABINET? YES NO

ARE YOU REMOVING THE EXISTING SIGN FACE? YES NO

IF FREESTANDING SIGN, ARE YOU REMOVING EXISTING POLE? YES NO

MESSAGE ON PROPOSED SIGN: _____

EXISTING SIGNS OF ALL TYPES ON SAME PREMISES

- # of free standing signs other than proposed _____ (please show on plot plan)

****INSTRUCTION TO APPLICANTS****

This application must be signed by the owner of the property on which the sign is to be erected by the contractor who will be responsible for its installation, by owner of the sign, itself, and by any tenant to whom the property or sign is rented or leased. Sixteen (16) copies of detailed construction plans and sixteen (16) plot plans must accompany the application. The plot plan must show all lot dimensions, street right of way, widths, locations and sizes of all existing building on the lot, location of existing signs keyed by number list above, and proposed locations of new sign in relation to building and all property lines.

I hereby certify that the information contained in this application is true and correct to the best of my knowledge and that all work will be performed in conformance with City of Bryant regulations.

Walter J. Scott

2/8/18

SIGNATURE OF SIGN CONTRACTOR

DATE

I hereby certify that the information contained in this application is true and correct to the best of my knowledge, that the erection of the proposed sign has my approval and that I will abide by all lawful regulations relating to signs including those with respect to their removal and annual registration.

J. M. Gold

SIGNATURE OF OWNER OF PROPERTY

2-5-18

DATE

[Signature]

SIGNATURE OF LESSOR OR TENANT

2/5/18

DATE

Tom Gibbons

SIGNATURE OF OWNER OF SIGN

2/2/18

DATE

"CONTACT PERSON" regarding this application (PLEASE PRINT)

Cara Criner
NAME

12001
ADDRESS

Interstate 30

Little Rock
CITY

Arkansas
STATE

72209
ZIP

501-562-2476
PHONE #

Real Estate Manager

BELOW IS FOR OFFICE USE ONLY

Zoning District _____ APPROVED DATE _____

PERMIT FEE

Building Fee \$ _____ Annual Permit Fee \$ _____ Total Fee \$ _____
(\$75.00 per sign) (\$100.00 per sign)

THE ABOVE APPLICATION HAS BEEN APPROVED FOR COMPLIANCE WITH

ZONING _____ APPROVED DATE _____
(Planning Commission)

BUILDING _____ APPROVED DATE _____
(Building Inspector)

Sign with
Taco Bueno Ad

Lamar Advertising

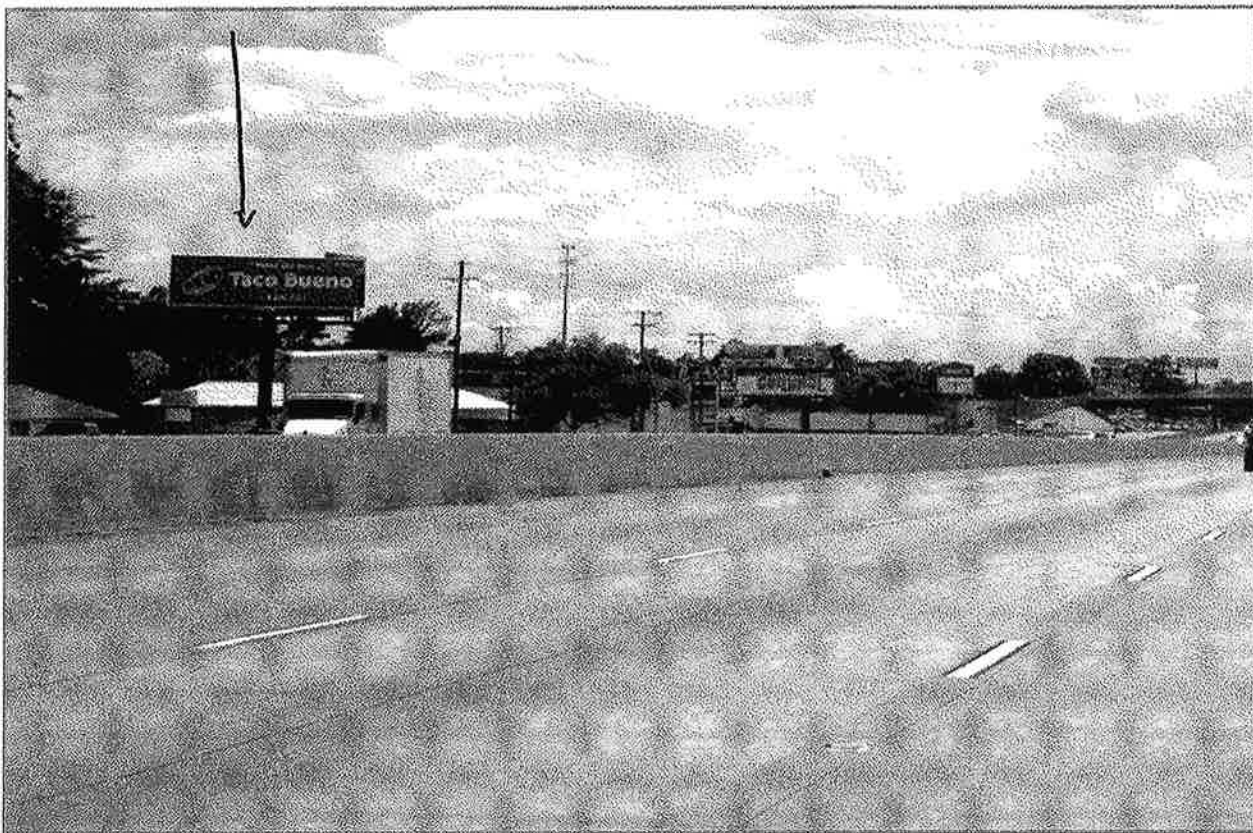

Panel 1068

Map of Panel 1068

Panel: 1068 TAB ID: 364048

Media/Style: Permanent Bulletin/Regular

Market: BENTON

Location: I-30 S/S 0.4 MI E/O REYNOLDS P1-EF

Facing/Read: East/Left

Panel Size: 10' 6" x 36' 0" [Spec Sheet](#)

Vinyl Size: 11' 6" x 37' 0"

Illuminated: YES

Total Weekly Impressions: 236,391

Lat/Long: 34.621050 / -92.492780

Rate:

Current Advertiser:

Misc:

Convert to
10 x 25 RMD.
Digital

Contact Lamar Advertising of Little Rock

Physical Address: 12001 Interstate 30 Frontage Road, Little Rock, AR 72209 - Mailing Address: P.O. Box 30006, Little Rock, AR 72260
Phone: 877-929-3920 - Fax: 501-568-0085

Lamar Advertising



Panel 1069

Map of Panel 1069

Panel: 1069 **TAB ID:** 364049

Media/Style: Permanent Bulletin/Regular

Market: BENTON

Location: I-30 S/S 0.4 MI E/O REYNOLDS P2-WF

Facing/Read: West/Right

Panel Size: 10' 6" x 36' 0" [Spec Sheet](#)

Vinyl Size: 11' 6" x 37' 0"

Illuminated: YES

Total Weekly Impressions: 317,095

Lat/Long: 34.621050 / -92.492780

Rate:

Current Advertiser:

Misc:

Contact Lamar Advertising of Little Rock

Physical Address: 12001 Interstate 30 Frontage Road, Little Rock, AR 72209 – Mailing Address: P.O. Box 30006, Little Rock, AR 72260
Phone: 877-929-3920 -- Fax: 501-568-0085



19?

23277
1-30

Permit #81550

Address

Payment Info

Address
City
State
Zip

Receipt # 1208958
Date 2/15/2017
Paid By THE LAMAR COMPANIES
Description I-30 SERVICE RD
Payment Type CHECK 3359786
Accepted By Cathy Fitch-Birdsong

Fees Paid

Fee	Fee Description	Factor	Total Fee Amount	Amount Paid
Billboard Permit	001-0700-4242 Billboard Permit/sign permit		0 100.00	100.00
			Total Payment: 100.00	

JBHX3 LLC

I-30 SOUTH
BRYANT, AR 72022

[Basic](#) [Land](#) [Sales](#) [Valuation](#) [Taxes](#) [Receipts](#) [Map View](#)

Basic Info

Parcel Number:	840-07190-000
County Name:	Saline County
Ownership Information:	JBHX3 LLC PO BOX 6 BRYANT AR 72089-0006
Property Address:	JBHX3 LLC I-30 SOUTH BRYANT, AR 72022
Billing Information ⓘ:	JBHX3 LLC PO BOX 6 BRYANT, AR 72089-0006
Total Acres:	0.00
Timber Acres:	0.00
Sec-Twp-Rng:	22-01S-14W
Lot/Block:	2/
Subdivision:	PIKEWOOD I
Legal Description:	2014-89045
School District:	253 BRYANT/BRYANT
Homestead Parcel?:	No
Tax Status:	Taxable
Over 65?:	No

JBHX3 LLC

I-30 SOUTH
BRYANT, AR 72022

[Basic](#) | [Land](#) | [Sales](#) | [Valuation](#) | [Taxes](#) | [Receipts](#) | [Map View](#)

Land Divisions

Land Type	Quantity	Front Width	Rear Width	Depth 1	Depth 2	Quarter
COMM LOT	5,050 sqft	50	50	101	101	

JBHX3 LLC
I-30 SOUTH
BRYANT, AR 72022

[Basic](#) [Land](#) [Sales](#) [Valuation](#) [Taxes](#) [Receipts](#) [Map View](#)

Sales History

Date	Price	Grantor	Grantee	Book	Page	Deed Type
12/3/2014	0	HOLDER	JBHX3 LLC	2014	89045	WD(Warranty Deed)
9/13/1993	0	HOLDER	HOLDER	377	702	WD(Warranty Deed)

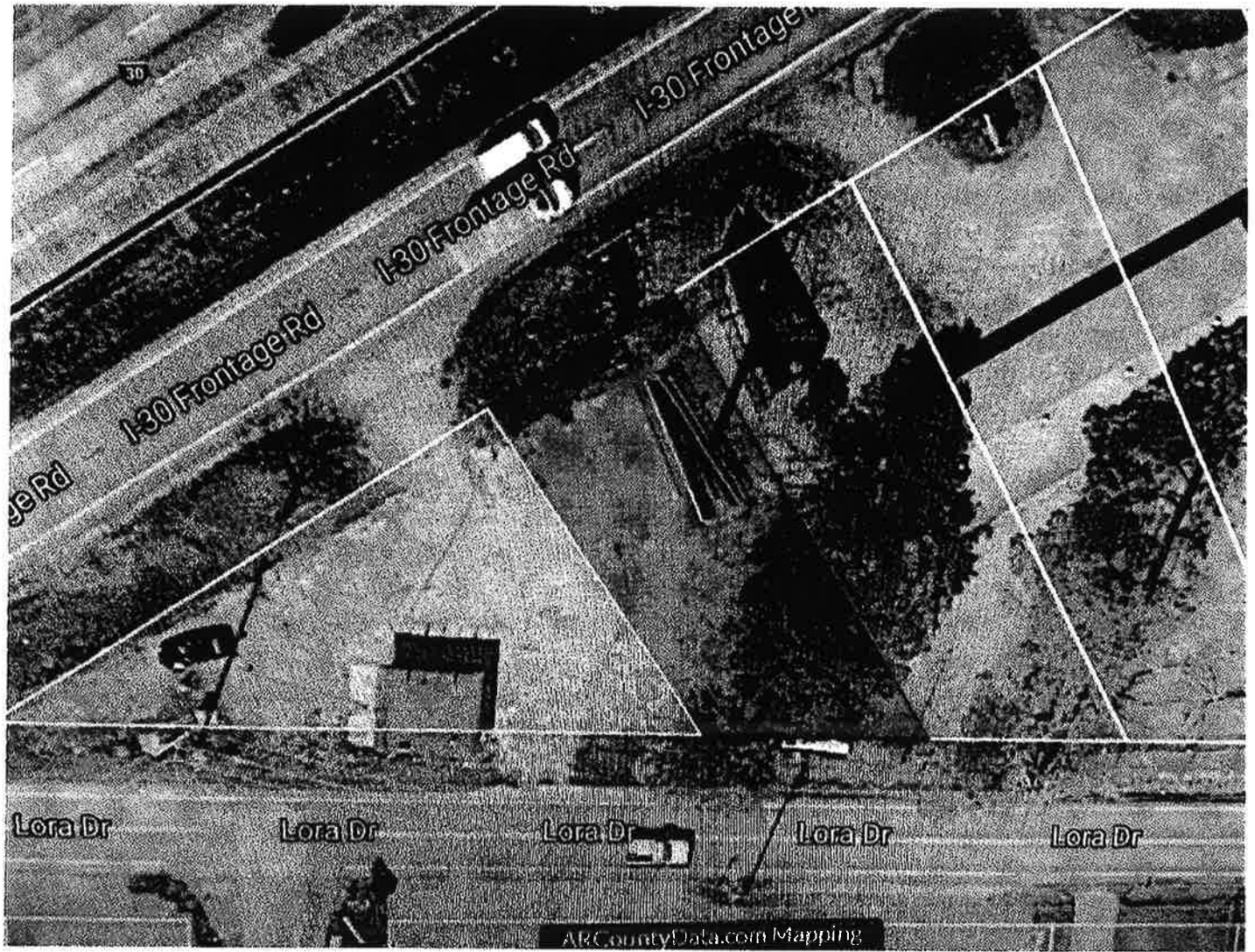

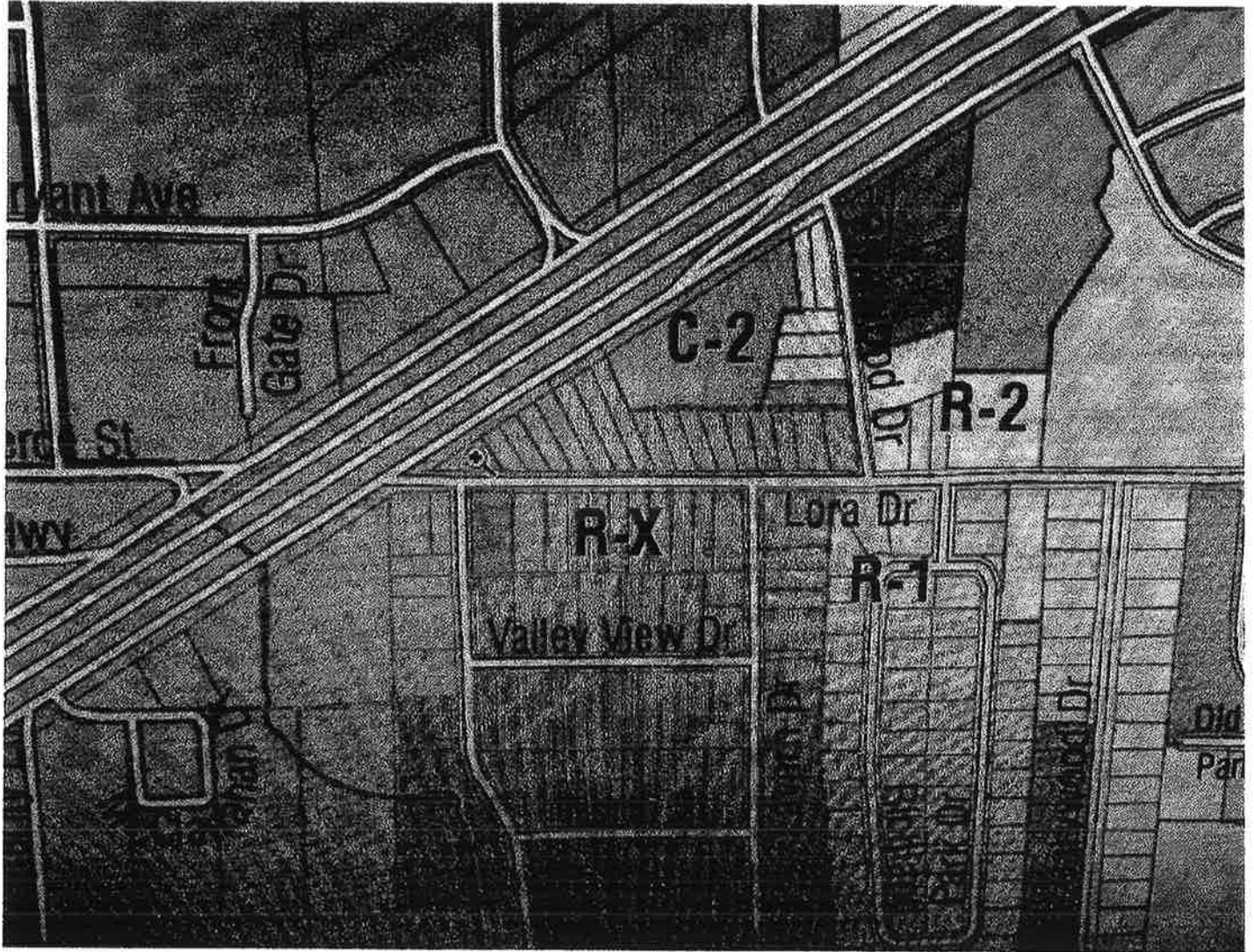



City of Bryant, Arkansas
Code Enforcement, Permits and Inspections
312 Roya Lane
Bryant, Ar 72022
501-943-0943

SIGN PERMIT APPLICATION

Applicants are advised to read the sign ordinance prior to completing and signing this form. The Sign Ordinance is available at www.cityofbryant.com

Site plan showing placement of sign and any existing signs on the property. A rendering of sign showing correct dimensions of all signs are required with application. Additional documentation may be required by Sign Administrator.

Date: 2/20/2018

Note: Electrical permits may be Required, Please contact the Permits Office at 501-943-0943 for more information.

**SIGN CO. OR
SIGN OWNER**

Name CUSTOM Advertising

Address 23478 I-30

City, State, Zip Bryant AR 72022

Phone 501-847-1000

Alternate Phone 501-209-2307

PROPERTY OWNER

Name _____

Address _____

City, State, Zip _____

Phone _____

Alternate Phone _____

GENERAL DETAILS

Name of Business Landers Corp. Plaza

Address/Location of sign 22461 I-30

Sign dimensions (height, length, width) 10'x40'x2'

Zoning Classification C Aggregate Surface Area (total all signs) _____

Height of sign from lot surface: Bottom 40' Top 50'

SIGN TYPE

Pole

____ Wall

____ Other (type) _____

Total sq. ft. _____

EXT. Billboard
Change To Digital
Monument

READ CAREFULLY BEFORE SIGNING

I, Jimmy Parker, do hereby certify that all information contained within this application is true and correct. I fully understand that the terms of the Sign Ordinance supersede the Sign Administrator's approval and that all signs must fully comply with all terms of the Sign Ordinance regardless of approval. I further certify that the proposed sign is authorized by the owner of the property and that I am authorized by the property owner to make this application. I understand that no sign may be placed in any public right of way. I understand that I must comply with all Building and Electrical Codes and that it is my responsibility to obtain all necessary permits.

Applicant's Signature

Date

Sign Administrator(or Designee) Approval

Date

Untitled Map

Write a description for your map.

Legend

Change To Digital

22461 I-30

Google Earth

© 2018 Google

7.24 ft



Indian Springs Baptist Church

23581 I-30S - Bryant, Arkansas 72022

March 6, 2018

Mr. Truett Smith, Director of Planning and Community Development
City of Bryant
210 SW 3rd Street
Bryant, AR 72022

Re: Indian Springs Baptist Church Building Addition

Dear Mr. Smith:

Thank you for allowing us to attend the DRC meeting on March 1, 2018 to discuss our building façade as designed to ask for approval of non-standard compliance. The intent of the design is for the front elevation of the building (inside the parking lot) to have 9 feet of red brick (matched to other buildings on our campus) with an additional 4 feet of a bronze slate colored awning, and 7 feet of architectural metal with concealed fasteners above this. On the left elevation (the side facing Lora Dr.), we will have the same brick 13 feet in total height to meet the top of the awning on the front elevation with the same architectural metal with concealed fasteners above the brick for 7 feet. This will be a total for these two sides of 65% of the approved finishes for the façade as the total building height is 20 feet.

As stated in our meeting, we have ordered our building and would be under hardship without the approval to proceed as designed. Due to the awning being part of the fabricated building and not part of the onsite construction, the production of the building would have to be stopped and design changed.

We respectfully request to be placed on the March 12, 2018 Planning Commission meeting for approval from the Commission at that time so that we can continue to move forward. Someone on the DRC requested that we submit colored drawings showing the exterior of the building. These drawing will be finished tomorrow, March 7, and I will drop them by your office as soon as I receive them so that you can let us know if they will be sufficient. If you have additional questions or comments please let me know immediately.

Sincerely,

Don Chancellor

Don Chancellor,
Executive Pastor

STANDING SEAM ROOF
AT METAL FRAMED AWNING

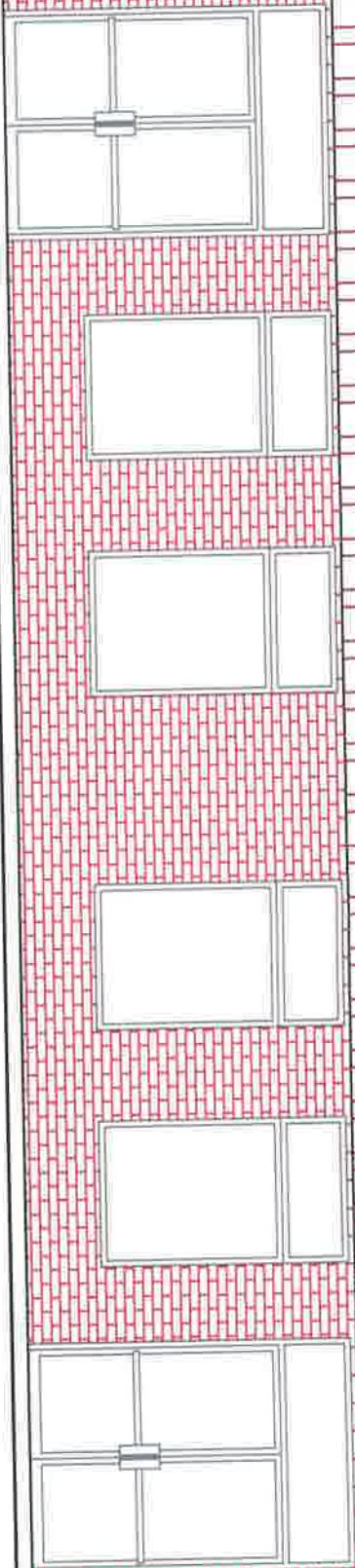

WALL SHEETING

FRONT ELEVATION

26 GA. COLORED
REVERSE R-PANEL
WALL SHEETING



FRONT ELEVATION

City of Bryant
Planning Commission
210 Southwest 3rd
Bryant, AR 72022

March 2, 2018

Re: Request for waiver for "The Stables" subdivision, Saline County, Arkansas.

Mr. Smith,

Please accept this letter as a request for waiver from the City of Bryant Subdivision Regulations and Master Transportation Plan for half street improvements along Snow Lane and Zuber Road, as well as the street requirements within the Subdivision. This project is located in the County, but within the City of Bryant extraterritorial planning jurisdiction. We're requesting that Snow Lane and Zuber Road be allowed to remain as existing county roads, and the private streets constructed within the Subdivision be constructed as per the Saline County Street Department Standards (Attached).

Please contact me with any questions you may have on this matter.

Very Sincerely,



Alan Schrader
(501) 847-1940

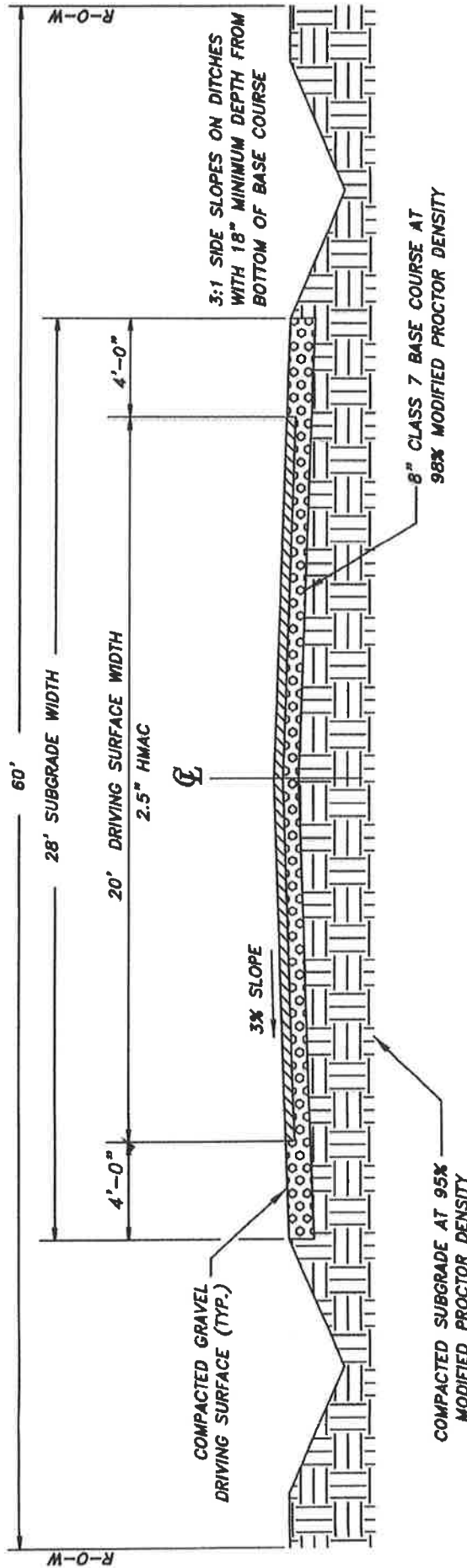

TYPICAL ROADWAY CROSS SECTION
N.T.S.

NOTE:
ROADWAY SHALL MEET AHTD SPECIFICATIONS

SECTION 3 – ADMINISTRATION AND ENFORCEMENT

Section 3.1: Administrative Official

The provisions of this Code shall be administered by the Administrative Official. This person or persons shall be designated by the Mayor. The Administrative Official may be provided with the assistance of such other persons as the Planning Commission and/or City Council may direct.

The Administrative Official shall enforce the provisions of this Code, and shall:

- A. Application Review and Approval: Examine and approve applications pertaining to the use of land, buildings, signs, or structures to determine if the application conforms with the provisions of this Code. The Administrative Official shall be responsible for issuing notices of approval or denial. Approval authority shall rest with the Administrative Official where not otherwise designated to the City Council, Planning Commission, or other committee created by the Planning Commission.
- B. Permits and Certificates of Occupancy: Issue or deny building permits and certificates of occupancy based upon compliance with this Code and other applicable codes. Written notice stating the reasons for denial will be provided with any building permit or certificate of occupancy that is denied.
- C. Records: Make and keep permanent records of actions taken. This shall include the issuance and denial of all building permits and certificates of occupancy, issuance of any approval or denials by the Administrative Official, actions and decisions of the planning commission and its committees, and records of violations and enforcement actions.
- D. Inspections: Conduct inspections of buildings, structures, and use of land as is necessary to determine compliance with the regulations of this Code.
- E. Enforcement: Enforce these regulations and take all necessary steps to remedy any condition found in violation.

Section 3.2: Planning Commission and Staff Committees

The following committees may be created and maintained to assist in long-range planning and carrying out these regulations:

3.2.1 Development Review Committee

The Development Review Committee shall be a staff committee and consist of the following:

- A. Members: The Development Review Committee voting members shall consist of the planning director, a planning department designee, public works director, a public works department designee, city engineer, chief building official or his/her designee, fire chief or his/her designee, Planning Commission chair or designee, and a Planning Commission liaison. The Planning

Commission chair appoint a designee to serve in his/her place and shall appoint a Planning Commission liaison. The Mayor shall appoint a City Council liaison to serve as a non-voting member and shall be provide input to the committee. Representatives from all private utility providers shall also be non-voting members of the committee and shall be invited to provide input to the committee.

- B. Meetings: The Development Review Committee shall officially meet bi-weekly according to a schedule maintained by the Planning and Community Development Department. Such meetings shall be public and open to public attendance.
- C. Purpose and Authority: The purpose of the Development Review Committee shall be to review all applications related to the Zoning Code, Subdivision Code, or other applicable code; and handle approvals as designated by this Code and other applicable city codes. All decisions made by the Development Review Committee may be appealed to the Planning Commission upon written request of appeal submitted to the Administrative Official.
- D. Duties: The duties of the Development Review Committee members shall be to attend all meetings, review and provide comments on applications submitted for review prior to meetings, and assist applicants through the review process.
- E. Report: The Development Review Committee shall provide reports to the Planning Commission and Board of Adjustment regarding each application reviewed by the Committee and/or any matters requiring the attention or action of the Planning Commission.
- F. Records: The Development Review Committee shall keep permanent records of all actions taken by the committee.

3.2.2 Long-Range Planning Committee

The Long-Range Planning Committee shall be an ad-hoc committee and its establishment shall rest at the discretion of the Planning Commission. When and if formed, it shall be governed by the following:

- A. Members: The members of the Long-Range Planning Committee shall consist of the Mayor, four members of the Planning Commission including the Planning Commission Chair or his/her designee, and up to three community representatives. The Mayor shall appoint the community representatives, and the Planning Commission Chair shall appoint the planning commissioners. The committee shall also consist of city staff as may be necessary to advise the committee in a non-voting capacity.
- B. Meetings: The Long-Range Planning Committee shall be chaired by the Mayor and shall meet at least quarterly to perform its duties as detailed in this section.
- C. Purpose: The purpose of the Long-Range Planning Committee shall be to monitor present and future planning issues.

- D. Duties: The duties of the Long-Range Planning Committee shall be to identify, research, and recommend, as needed, to the Planning Commission long range planning goals, reports, regulation changes, and procedural issues.
- E. Report: The Long-Range Planning Committee shall periodically report to the Planning Commission on the progress of the Long-Range Planning Committee and/or any matters requiring the attention or action of the Planning Commission.

Section 3.3: Building Codes

All fabrication, erection, construction, enlargement, alteration, repairs of buildings or structures shall meet the Arkansas Fire Prevention Code or other applicable state and city codes.

Section 3.4: Building Permits and Certificates of Occupancy

3.4.1 Building Permits

- A. No building or structure shall be erected, altered, or moved, without a building permit issued by the Administrative Official. No building permit shall be issued for the construction of any building or structure located on a lot or parcel subdivided or sold in violation of the provisions of this Code or other applicable city/state regulations. The City of Bryant shall not have any obligation to issue certificates of occupancy or to extend utility services to any parcel created in violation of this Code or other applicable city/state regulations or to any land or structure where a violation of this Code or other applicable city/state regulation exists.
- B. A permit will be issued only when the application has been approved by the City of Bryant as meeting all the requirements of this Code and other applicable codes. The permit must be posted in a conspicuous place on the front of the premises.
- C. All applications for a building permit shall be accompanied by a survey in duplicate drawn to scale, showing the actual dimensions of the lot to be built upon, the size of the building to be erected, the use to which the building or land is to be put, the location of the building upon the lot, and such other information as may be necessary to provide for the enforcement of this Code. A record of each application with attached copy of any approved plan shall be kept by the Administrative Official.
- D. If any construction, alteration or installation is done in or on any building, structure, or premise, or any part without the permits required, the Administrative Official shall issue a stop order, directing such construction to cease immediately.
- E. If, after a stop order has been issued, there is any reason to believe that further work on such construction, alteration or installation is being done, has been done, or that such maintenance or operation is being carried on, the Administrative Official shall notify the City Attorney. The City Attorney shall proceed to obtain an injunction as provided by law.

3.4.2 Certificates of Occupancy

- A. No building erected or structurally altered shall be used, occupied or changed in use until a Certificate of Occupancy has been issued by the Administrative Official, stating that the building or proposed use of a building or premises complies with the provisions of this Code and other applicable codes. The Administrative Official shall maintain a record of all Certificates of Occupancy.
- B. The Administrative Official may revoke a Certificate of Occupancy when it is found that the building or land does not conform to the use or condition of use for which it is approved.

3.4.3 Temporary Certificate of Occupancy

- A. A temporary Certificate of Occupancy may be issued by the Administrative Official for a portion or portions of a building, which may safely be occupied prior to final completion of the building. A Temporary Certificate of Occupancy shall be valid for a period not exceeding sixty (60) days.
- B. Where a temporary Certificate of Occupancy is issued, the applicant must provide a cash deposit of \$1,500.00 to the city. Upon issuance of the permanent certificate of occupancy to the applicant, the cash deposit shall be returned to the applicant.

Section 3.3: Enforcement

- A. It is illegal to build, construct, reconstruct, alter, maintain, or use any land, building, or structure in violation of this code or any order/decision of the City Council, Board of Adjustment, Planning Commission or its committees, or Administrative Official.
- B. Whenever a violation of these regulations occurs, or is alleged to have occurred, any person may make a complaint. Such complaint shall state the causes and basis of the complaint, and shall be made with the Administrative Official. He/she shall record such complaint and determination if a violation has occurred or is occurring.
- C. If the Administrative Official finds that the provisions of these regulations are being violated, he/she shall notify in writing the person responsible for such violations, indicating the nature of the violation and ordering the action necessary to correct it.
- D. Should the person responsible for such violations fail to take the necessary action to correct it, the Administrative Official shall notify the City Attorney, and the City Attorney shall within seven (7) days apply for an injunction, mandamus, or other process to prevent, enjoin, abate, or remove said violation to these regulations.

Section 3.4: Violations and Penalties

- A. Any person, firm, or corporation that violates any provision of these regulations or amendments shall be guilty of a misdemeanor and on conviction shall be fined not less than fifty dollars

(\$50.00) and not more than five hundred dollars (\$500.00). Each day that violation of these regulations is in effect constitutes a separate offense and is subject to additional fines of not less than fifty dollars (\$50.00) and not more than five hundred dollars (\$500.00) per day.

- B. The owner of record of any real property who participates in, assists, directs, creates, or maintains any situation in violation of this Code may be held liable for such penalties or remedies required. Tenants, occupants, architects, engineers, builders, developers, contractors, agents, or persons that assist, direct, create, or maintains any situation in violation of this Code may be held liable for such penalties or remedies required.
-

AMENDMENT TO SECTION 5.2

<i>Permitted Uses</i>	<i>R-1</i>	<i>R-1.S</i>	<i>R-2</i>	<i>R-E</i>	<i>R-M</i>	<i>Special Provisions</i>
A. Residential						
Accessory Dwelling Units	CU	CU	CU	CU	CU	
Accessory Structures and Uses	P	P	P	P	P	
Single-Family Dwelling	P	P	P	P	P	
Two-Family Dwelling	P	X	X	X	CU	
Multi-Family Dwelling	X	X	X	X	X	
Mobile Home	X	X	X	X	X	
Manufactured Home	X	X	X	X	P	
Manufactured Home Park	X	X	X	X	CU	
Townhouse	X	X	X	X	X	
Model Home – Temporary (18 month limit)	P	P	P	P	X	
B. Commercial						
Bed & Breakfast	X	X	X	CU	X	
Child Care Center	CU	CU	CU	CU	CU	
Elder/Adult Care Center	CU	CU	CU	CU	CU	
Home Occupation	P	P	P	P	P	
Short Term Rental	CU	CU	CU	CU	CU	
C. Community Facilities and Public Utilities						
Cemetery	CU	CU	CU	P	CU	
Church or other place of worship	P	P	P	CU	P	
Community building, public	CU	CU	CU	CU	CU	
Public Utility Buildings/Facilities	CU	CU	CU	CU	CU	
Residential establishment for care of alcoholic, drug, or psychiatric patients	X	X	X	X	X	
Half-way House	X	X	X	X	X	
Hospital, health center, institution for aged or children, and extensions or additions to existing	CU	CU	CU	CU	CU	
Library	CU	CU	CU	CU	CU	
Nursing or rest home and extensions or additions to existing ones	CU	CU	CU	CU	CU	
Park or playground	CU	CU	CU	CU	CU	
School, public, parochial, or private non-profit	CU	CU	CU	CU	CU	
D. Agricultural						
Animal husbandry, dairying, and pasturage	X	X	X	CU	X	
Field crops, horticulture, or nursery truck gardening, but not including retail sales on the premises – Gardens under 2 acres are permitted in all districts	X	X	X	P	X	
E. Other						
Other similar uses, not specifically listed above	CU	CU	CU	CU	CU	

Section 17.1: Accessory Dwelling Units

Accessory Dwellings Units shall only be allowed on lots where there is an existing single-family residence. An existing single-family dwelling can be converted to an accessory dwelling unit. Existing Accessory Dwelling Units constructed prior to April 30, 2018, made non-conforming by these regulations shall be considered legal and conforming and may be reconstructed if demolished or destroyed for any reason.

LANGUAGE TO BE ADDED TO DEFINITIONS

Accessory Dwelling Unit: A smaller, secondary site-built dwelling unit on the same lot as an existing single-family dwelling. The unit includes its own independent living facilities with provisions for sleeping, cooking, and sanitation, designed for residential occupancy independent of the primary dwelling unit.

17.1.1 Standards

- A. Owner Occupancy: The property owner must maintain permanent residence in either the principal structure or the accessory dwelling unit.
 - B. Maximum Occupancy: Occupancy of the Accessory Dwelling Unit shall be limited to one family.
 - C. Number Allowed: One (1) Accessory Dwelling Unit per principal structure.
 - D. Size Limits: Living space in the Accessory Dwelling Unit must be less than forty (40) percent of the size of the principal structure or 1,000 square feet in gross floor area, whichever is less. It must also be at least 300 square feet in gross floor area.
 - E. Setbacks and Height: The units shall meet all the required setbacks for accessory structures of the zone in which it is located. The height of the unit shall not exceed that of the principal structure, without approval of a conditional use permit.
 - F. Location: The unit must be placed within the rear yard of the lot, behind the principal structure.
 - G. Design: The façade materials of the unit must match or complement the façade materials of the principal structure. The applicant shall provide a materials list at the time of approval for the structure. The Development Review Committee shall have the authority to approve façade materials which do not meet this standard.
 - H. Parking: One paved off-street parking space shall be provided.
 - I. Accessory Structure Conversion: An existing accessory structure may be converted in whole or in part to an accessory dwelling unit provided the accessory structure is conforming and the structure or portion of the structure deemed an accessory dwelling unit meets the requirements of this Section.
-

Section 17.12: Home Occupations

Home occupations are subject to the following limitations:

- A. Must not involve the use of commercial vehicles operating from the residence.
- B. Must be clearly secondary to the residential purpose of the structure and does not involve a change in the residential character or appearance of the structure.
- C. Does not require use of an accessory building or involve activity outside the principal structure other than would be normally associated with a residential use.
- D. Must not occupy more than twenty-five (25) percent of the gross floor area of one floor of the structure.
- E. Must not involve the external display of goods and services.
- F. Must be conducted solely by a person or persons residing in the structure.
- G. Must meet the definition of a home occupation.
- H. Must not involve personal services such as massage or hair care. Must not involve automotive repair, appliance repair, heavy equipment repair, kenneling of animals, or veterinary surgery.

Section 17.15: Live/Work Units

LANGUAGE TO BE ADDED TO DEFINITIONS

Live/Work Unit: A building use jointly for commercial and residential purposes where the residential use of the building is secondary or accessory to the primary commercial use.

TO BE PERMITTED IN C-1, C-2.

17.15.1: Standards

Live/Work Units shall comply will the following standards.

- A. Residential use of the structure and property shall be clearly secondary or accessory to commercial use of the structure.
- B. The residents of the Live/Work Unit shall be limited to one family, which must include the owner or employee of the commercial use of the structure.

- C. The commercial use of the property must be otherwise allowed in the zone in which it is located, but shall not include sexually oriented businesses or massage parlors.
 - D. The front façade of the structure must be maintained to appear commercial in nature.
 - E. The commercial and residential portions of the building shall be physically separated by walls, with those portions of the structure accessible to the public occupied by commercial space.
 - F. The residential portions of the structure must have separate kitchen and bathroom facilities.
 - G. All portions of the structure must meet the appropriate requirements of the Arkansas State Fire Prevention Code.
-

Section 17.23: Residential Design Standards

ADD DEFINITION

Snout House: A single-family dwelling constructed with a distance greater than eight (8) feet between the vertical plane of the front door and the vertical plane of the front of the garage door when placed on the same façade.

17.23.1: Purpose

- A. To ensure harmonious and compatible residential design that protects the health, safety, and welfare of the community.
- B. To implement the provisions of the City's Comprehensive Plan.
- C. To limit the development of houses that detract from the visual and aesthetic quality of the community.
- D. To achieve a streetscape that contributes to lessening the impacts of houses with protruding garages.
- E. To promote livability in residential streetscapes.
- F. To encourage alternatives to protruding front-loading garages, such as side-loading or rear-loading garages.

17.23.2: General Standards

All single-family dwellings, two-family dwellings, and manufactured homes except those within a manufactured home park are subject to the following standards:

- A. Dwellings shall have a minimum width or length of 20 ft. on any side.

- B. Dwellings shall be oriented such that the front door of the structure faces a street.
- C. All dwelling units that do not have a built-in front porch as part of the structure shall have a covered front landing, accessible by stairs with handrails, if necessary. The landing shall be at least six feet by six feet and oriented to the front yard.
- D. Dwellings shall be clad in wood, rock, masonry, stucco, EIFS, vinyl, or fiber-cement siding. Other materials may be used subject to DRC approval. Existing structures may only be reclad in conformance with these standards.
- E. Roofs shall have a minimum pitch of (4/12). Other roof forms such as flat roofs may be used subject to DRC approval.
- F. Any transportation elements including axles and hitches shall be removed from the structure.
- G. Units shall be set up and anchored in accordance with regulations set forth by the Arkansas Manufactured Home Commission, if applicable.
- H. Units shall have a solid masonry or concrete perimeter foundation around the base of the perimeter of the structure.
- I. Dwellings moved in shall be new and under warranty or inspected by the City's Administrative Official prior to being moved on site (if located outside the city limits, inspection may be conducted by electronic means or through photos) to ensure the dwelling will be inhabitable in a safe manner based upon the following standards:
 - 1. All roofing material shall be secure without gaps or damaged shingles;
 - 2. All windows shall be operative without broken panes or damaged trim or screening;
 - 3. All exterior siding shall be in place and undamaged with no dents, tears, or burned sections;
 - 4. All kitchen and bathroom facilities shall be fully operational and all mechanical equipment in good working order;
 - 5. Any attached gutters shall be secure and functional;
 - 6. All cornice materials shall be in place and undamaged;
 - 7. Paint shall be uniform and unblemished;
 - 8. Doors shall be plumb and fully operational;

9. Flooring shall be structurally undamaged and secure.

17.23.3: Supplemental Standards

The requirements of this subsection shall apply only to new construction of a single-family dwelling with a size of less than 1,800 square feet of gross floor area that is located within a platted subdivision approved by the Bryant Planning Commission after April 1st, 2018.

- A. There shall be no more than eight (8) feet from the vertical plane of the garage door to the vertical plane of the front door when the garage is placed at the front of the dwelling.
- B. To encourage front porches to reduce the impact of the snout house, the eight (8) foot distance between the vertical plane of the garage door and vertical plane of the front door may be measured from the middle or median of the depth of any covered front porch, provided the porch has a horizontal width of at least eight (8) feet and a depth of at least five (5) feet.
 1. Depth shall be measured from the façade wall to the edge of the porch or any required railing/porch post, whichever is less.
 2. In such cases, the vertical plane of the front door shall not have a distance of greater than two (2) feet from the vertical plane front façade wall.
- C. A single-family dwelling not meeting these requirements may be approved upon review of the Development Review Committee, if it can be found by the Development Review Committee that the requirements of the subsection impose a substantial burden upon the property owner such that development of the property is exceedingly impractical. An applicant may apply for approval of multiple single-family dwellings at one-time.